



Vol. 1 2011

Leading Through  
Innovation  
Take A Peek  
at up coming  
Products for 2011!



809 W. Santa Anita St., San Gabriel, CA 91776

Phone: 626-588-2530 • Fax: 626-588-2525 • [www.odysseygear.com](http://www.odysseygear.com)

Product News Guide

Finally. A video recorder  
that **sounds** as good as it looks.



Introducing VideoTrack – The best way to capture video that sounds as good as it looks. Equally at home at the gig, in your backyard or on vacation, VideoTrack delivers crisp, clear video with exceptional audio clarity thanks to a pair of built-in hi-quality stereo condenser microphones. A bright 2.4" LCD screen lets you easily monitor your footage, while 3X zoom gets you close to the action, even from afar. The included software gives you easy drag-and-drop file transfer and direct-to-YouTube upload capability so you can edit and share your masterpiece in no time flat.

Don't settle for video with inferior audio. Start capturing your life with Video Track today.

**VIDEOTRACK**  
HANDHELD AUDIO | VIDEO RECORDER

**ALESIS**  
alesis.com



**SHOW  
SOLUTIONS**  
Strong Structural Support  
Made Easy!



The key to our success has been and will continue to be our uncompromising passion for service, our culture of complete accountability and a consistent channel of open communication.

We design it right, build it with quality and deliver it on time...Always.

[www.showsolutions.com](http://www.showsolutions.com)

**BLACK LABEL SERIES CASES (6-21)**

STANDARD CD/DIGITAL DJ COFFINS	6
STANDARD TURNTABLE CASES AND DJ COFFINS	7
CD/DIGITAL MEDIA PLAYER CASES	7
STANDARD AND GLIDE STYLE DJ MIXER CASES	8
GLIDE STYLE CD/DIGITAL DJ COFFINS & TURNTABLE DJ COFFINS	9
GSX GLIDE STYLE CD/DIGITAL DJ COFFINS	10
REMIXER SERIES GLIDE STYLE DJ COFFINS	11
FOLD-OUT STANDS	12
GT GLIDE STYLE DIGITAL DJ CONTROLLER CASES	13
NUMARK NS7 AND MIXDECK CASES	14-15
AMP RACKS	17
STANDARD COMBO RACKS	19
GLIDE STYLE COMBO RACKS	20
UTILITY CASE AND TRUCK PACKS	21

**DESIGNER DJ SERIES CASES (22-23)**

DENON CD/DIGITAL DJ COFFINS	22
STANDARD DJ MIXER CASES	22
CD/DIGITAL MEDIA PLAYER CASES	23
TURNTABLE CASES	23

**FLIGHT ZONE & FLIGHT READY CASES (24-70)**

STANDARD CD/DIGITAL DJ COFFINS	24-25
DENON CD/DIGITAL DJ COFFINS	25
PIONEER CD/DIGITAL DJ COFFINS	27
STANDARD TURNTABLE DJ COFFINS	28
GSX GLIDE STYLE CD/DIGITAL DJ COFFINS	29
GLIDE STYLE CD/DIGITAL DJ COFFINS	30
GLIDE STYLE TURNTABLE DJ COFFINS	31
REMIXER SERIES GLIDE STYLE DJ COFFINS	33
CD/DVD/VIDEO GAME DISC & LP/UTILITY CASES	34
STANDARD CD/DIGITAL MEDIA PLAYER CASES	35
PIONEER CD/DIGITAL MEDIA PLAYER CASES	35
TURNTABLE CASES	37
STANDARD DJ MIXER CASES	39
GLIDE STYLE DJ MIXER CASES	40
CD/DIGITAL MEDIA MIXER CASES AND COMBO RACKS	41
NUMARK HDMIX CD/MEDIA PLAYER MIXER CASE	42
NUMARK NS7 AND MIXDECK CASES	43, 45
DIGITAL DJ CONTROLLER CASES	47
AKAI APC40 DIGITAL CONTROLLER CASE	49
SHOCK MOUNT RACKS	51
AMP RACKS	52
SPACE SAVER RACKS & COMBO RACKS	53
STANDARD COMBO RACKS	54
GLIDE STYLE COMBO RACKS	55
EFFECTS RACKS	56
TRIPLE COMBO RACKS	57
MICROPHONE CASES	57
GUITAR AMP HEAD & SPEAKER CABINET CASES	58
GUITAR COMBO AMP CASES	59
GUITAR PEDAL BOARD CASES	60
KEYBOARD CASES & COVERS	61
LIVE SOUND MIXER CONSOLE CASES	62-63
LIGHTING / UTILITY CASES	64
MOVING HEADS CASES	65
PLASMA/LCD/LED SCREEN CASES	66
STAKPAK UTILITY CASES	67
UTILITY / TRUCK PACK CASES	68-69
UTILITY CARRYING CASES	70

**INJECTION MOLDED CASES (71)**

UTILITY CASES: WATERTIGHT & DUSTPROOF	71
CARPETED CASES & RACKS (72-85)	
GLIDE STYLE DJ COFFINS	72
TURNTABLE CASES & STANDARD TURNTABLE DJ COFFINS	73
BRAND SPECIFIC & COMBO DJ COFFINS	74
TWIN RACKS	75
GEMINI CD/DIGITAL MEDIA MIXER CASE	75
CD/DIGITAL MEDIA MIXER RACKS	76
CD/DVD/VIDEO GAME DISC CASES	77
LP/UTILITY CASES	78
STANDARD SERIES AMP RACKS	79
PRO SERIES AMP RACKS	80
PRO SERIES COMBO RACKS & CXC SERIES COMBO RACKS	81
CXP SERIES COMBO RACKS	82
CXG SERIES COMBO RACKS & SLIDE STYLE COMBO RACKS	83
LAPTOP SLIDE STYLE COMBO RACKS	84
STUDIO RACKS	85

**KROM CASES (86-87)**

CD/DVD/VIDEO GAME DISC CASES	86-87
LP/UTILITY CASES	87

**BAGS (88-92)**

REDLINE DIGITAL GEAR BAGS	88-89
BCURBAN17 DJ BAG, HEADPHONE/UTILITY POUCH	90
RACK BAGS	91
DRUM BAGS	92

**ACCESSORIES (93-127)**

MOVING EQUIPMENT: LOAD-N-GO CART 2 / DOLLY PLATES	93
ROCK N ROLLER MULTI-CARTS	95
COMPACT BACKLIT LED KEYBOARDS	96-97
FOLD-OUT STANDS: CARPETED AND FLIGHT ZONE	98-99
X STANDS	100
DJ TABLES: TRUSS AND CARPETED	101
LSTAND LAPTOP/GEAR STANDS: STANDARD BLACK & DESIGNER DJ SERIES	102-105
L-EVATION HEAVY-DUTY LAPTOP/GEAR STANDS	106-107
ORTOFON PRODUCTS	109-111
MISCELLANEOUS DJ ACCESSORIES: TURNTABLE CARTRIDGE CASES AND DJ CHAIR	112
MISCELLANEOUS DJ ACCESSORIES: FACE PLATES AND BATTLE TRAYS	113
LIGHTING STANDS AND LIGHTING STAND ACCESSORIES	114-115
SPEAKER STANDS & SPEAKER STAND ACCESSORIES	116-117
CRANK UP STANDS & CRANK UP STAND ACCESSORIES: SPEAKER & LIGHTING	117-119
VSS MOBILE VIDEO SCREEN SYSTEMS	120
SCRIM WERKS: PROJECTION SCREENS, TRIPOD SCRIMS, X-STAND & TRUSS SLIP SCREENS	121-123
ULTRABEAM	124
RACK ACCESSORIES: CD TRAY GUARD, WERK LIGHTS	124-125
RACK ACCESSORIES: DRAWERS, FANS, PANELS, RAILS, SCREWS, SHELVES, & TRAYS	126-127

**INDEX (128-129)**
**BC CUSTOM CASES (130-131)**

Disclaimer: Odyssey Innovative Designs strives to ensure the accuracy of the information contained herein. However, due to the constant change in raw materials available and used, improvements in design, typographical errors, and other factors may be beyond our control. We reserve the right to make changes in designs, styles, features, colors, dimensions, and other specifications without prior notice. Copyrighted logos and trademarks are those of the respective company: Akai, Alesis, Allen & Heath, American Audio, Apple, Avertec, B-52, BBE, Behringer, Boss, Casio, Chauvet, Coemar, Cortex, Crown, Dell, Denon, Digidesign, Drawmer, Elation, Fender, Gemini, Gemsound, Hercules, Korg, M-Audio, Mackie, Marshall, Martin, Mesa, Multi-Cart, Numark, Ortofon, Pearl River, Peavey, Pioneer, Rane, Robe, Roland, Serato, Shure, Sony, Soundcraft, Tascam, Technics, Traktor Scratch, Vestax, Vox, Yamaha, etc. Equipment pictured not included. Actual product weights may vary due to the natural density of the wood.

**Black Label** SERIES

**CD/DIGITAL DJ COFFINS  
LARGE FORMAT**



Recessed  
Rollers for easy  
transportation



\*width adjustment  
foam included

Large format CD/Digital DJ  
Coffins fit players such as:  
American Audio Flex 100 MP3/  
Radius1000/3000  
Denon DN-S3700  
Gemini CDJ210/600  
Numark NDX800/V7  
Pioneer CDJ-1000MK3/2000  
800MK2/850  
Stanton C-324

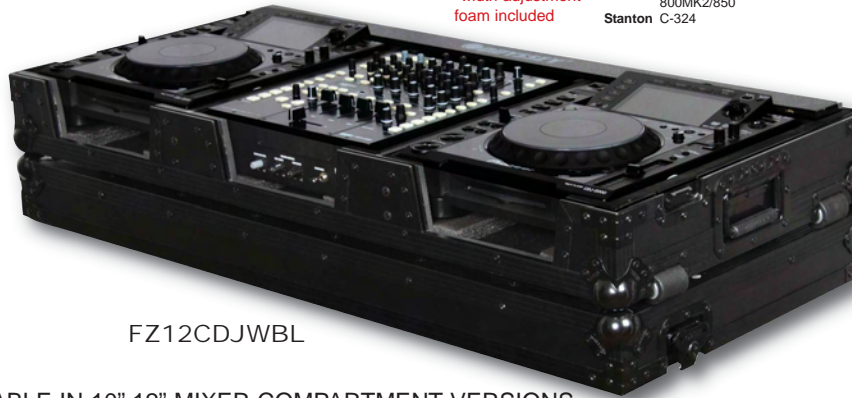

FZ12CDJWBL

AVAILABLE IN 10", 12" MIXER COMPARTMENT VERSIONS

MODEL	DIMENSIONS	WEIGHT	FITS
FZ10CDJWBL	34.5" x 9" x 18.5"	38 lbs.	10" mixer, (2) large format CD/Digital Media Players
FZ12CDJWBL	43" x 9.5" x 19"	40 lbs.	12" mixer, (2) large format CD/Digital Media Players

**Black Label** SERIES

**TURNTABLE CASES AND DJ COFFINS**



Recessed  
Rollers for easy  
transportation

FZ1200BL



FZBM10WBL

MODEL	DIMENSIONS	WEIGHT	FITS
FZ1200BL	21.5" x 9.5" x 21.5"	20 lbs.	1200 style turntables
FZBM10WBL	47" x 9" x 22.5"	53 lbs.	10" mixer, (2) 1200 style turntables in Battle position
FZBM12WBL	49" x 9" x 22.5"	56 lbs.	12" mixer, (2) 1200 style turntables in Battle position

\*Our turntable coffins can hold Numark, Stanton, as well as Technics 1200 style turntables!

**Black Label** SERIES

**CD/DIGITAL DJ COFFINS  
MEDIUM FORMAT**



\*width adjustment  
foam included

Medium format CD/Digital DJ  
Coffins fit players such as:  
American Audio CDI-300  
Denon DN-S1200/S700  
Gemini CFX-20  
Numark ARC 3/Axis-4/Axis-9  
NDX200/NDX400  
Pioneer CDJ-200/CD-J350/  
CDJ-400  
Stanton S-252/300  
Vestax CDX-05MBK



FZ10CDiWBL



Recessed  
Rollers for easy  
transportation

MODEL	DIMENSIONS	WEIGHT	FITS
FZ10CDiWBL	34.5" x 9" x 19"	37 lbs.	10" mixer, (2) medium format CD/Digital Media players

**Black Label** SERIES

**CD/DIGITAL MEDIA PLAYER CASES**



\*width adjustment  
foam included

Large format CD/Digital DJ  
Coffins fit players such as:  
American Audio Flex 100 MP3/  
Radius1000/3000

Denon DN-S3700  
Gemini CDJ210/600  
Numark NDX800/V7  
Pioneer CDJ-1000MK3/2000  
800MK2/850  
Stanton C-324

Medium format CD/Digital DJ  
Coffins fit players such as:

American Audio CDI-300  
Denon DN-S1200/S700  
Gemini CFX-20  
Numark ARC 3/Axis-4/Axis-9  
NDX200/NDX400  
Pioneer CDJ-200/CD-J350/  
CDJ-400  
Stanton S-252/300  
Vestax CDX-05MBK



FZCDJBL

MODEL	DIMENSIONS	WEIGHT	FITS
FZCDiBL	18" x 9" x 12"	13 lbs.	medium format CD/Digital Media player
FZCDJBL	15" x 9" x 19"	17 lbs.	large format CD/Digital Media player

**Black Label™** DJ MIXER CASES

FZ10MIXBL

FZ12MIXBL

MODEL	DIMENSIONS	WEIGHT	FITS
FZ10MIXBL	13" x 9.5" x 21.5"	18 lbs.	10" mixer
FZ12MIXBL	15.5" x 9.5" x 19.5"	19 lbs.	12" mixer

**Black Label™** GLIDE STYLE™ DJ MIXER CASES

FZGS10BL

FZGS12MIXBL

These Black Label™ Patented Glide Style™ Mixer cases feature a sliding laptop platform mounted up above the mixer compartment. Incorporated into the FZGS10/12MIX case is an extra deep cable well area, plenty of room for power supplies as well as cables. Standard Flight Zone™ cases also available. (pg40)

MODEL	DIMENSIONS	WEIGHT	FITS
FZGS10MIXBL	21.25" x 13" x 14.75"	33 lbs.	Holds most 10" Mixers
FZGS12MIXBL	20.5" x 13" x 16.25"	32 lbs.	Holds most 12" Mixers
FZGS10BL	22.25" x 12" x 20"	32 lbs.	Up to 10U 19" rack mount Mixers

\*These cases are not designed to transport laptops.

**Black Label™** GLIDE STYLE™ CD/DIGITAL DJ COFFINS • LARGE FORMAT

\*width adjustment foam included  
 Large format CD/Digital DJ Coffins fit players such as:  
 American Audio Flex 100 MP3/Radius1000/3000  
 Denon DN-S3700  
 Gemini CDJ210/600  
 Numark NDX800/V7  
 Pioneer CDJ-1000MK3/2000 800MK2/850  
 Stanton C-324



Recessed Rollers for easy transportation

FZGS12CDJWBL

MODEL	DIMENSIONS	WEIGHT	FITS
FZGS10CDJWBL	40.5" x 12.5" x 19.5"	48 lbs.	10" mixer, (2) large format CD/Digital Media players
FZGS12CDJWBL	42.5" x 13" x 19"	49 lbs.	12" mixer, (2) large format CD/Digital Media players

\*These cases are not designed to transport laptops.

**Black Label™** GLIDE STYLE™ TURNTABLE DJ COFFINS

Flushed platform for easy access to the left turntable controls



Recessed Rollers for easy transportation

FZGSBM10WBL

MODEL	DIMENSIONS	WEIGHT	FITS
FZGSBM10WBL	45" x 12.5" x 22"	52 lbs.	10" mixer, (2) 1200 style turntables in battle mode
FZGSBM12WBL	47.5" x 12.5" x 22"	54 lbs.	12" mixer, (2) 1200 style turntables in battle mode

\*Our turntable coffins can hold Numark, Stanton, as well as Technics 1200 style turntables!  
 \*These cases are not designed to transport laptops.

**BLACK LABEL**  
SERIES

**GSX GLIDE STYLE™ CD/  
DIGITAL DJ COFFINS**



Features lockable laptop compartment

FZGSX12CDJWBL



\*width adjustment foam included  
Large format CD/Digital DJ Coffins fit players such as:  
American Audio Flex R100 MP3/ Radius1000/3000

- Denon DN-S3700
- Gemini CDJ210/600
- Numark NDx800/V7
- Pioneer CDJ-1000MK3/2000 800MK2/850
- Stanton C-324



Recessed Rollers for easy transportation

Odyssey's GSX Glide Style™ Series DJ coffins feature the ability to safely store your laptop inside the actual laptop platform that sits right above the mixer compartment. To access the compartment, the top section slides open left and right and includes key locks for security allowing the DJ to take a break from the booth without having to worry about theft. Just another innovative design to the Glide Style™ case family. Standard Flight Zone® cases are also available. (pg.29)

MODEL	DIMENSIONS	WEIGHT	FITS
FZGSX10CDJWBL	41.5" x 12.75" x 19.5"	51 lbs.	10" mixer, (2) large format CD/Digital Media players
FZGSX12CDJWBL	42.75" x 12.25" x 19.5"	55 lbs.	12" mixer, (2) large format CD/Digital Media players

\*These cases are not designed to transport laptops.

**BLACK LABEL**  
SERIES

**GLIDE STYLE™ / DJ COFFINS**

**Remixer**  
SERIES

**NEW  
ARRIVAL**



\*width adjustment foam included

Large format CD/Digital DJ Coffins fit players such as:  
American Audio Flex 100 MP3/ Radius1000/3000

- Denon DN-S3700
- Gemini CDJ210/600
- Numark NDx800/V7
- Pioneer CDJ-1000MK3/2000 800MK2/850
- Stanton C-324



Recessed Rollers for easy transportation



FZGSP10CDJWBL



FZGSPBM12WBL

\*Our turntable coffins can hold Numark, Stanton, as well as Technics 1200 style turntables!

FZGSP12CDJWBL



As the evolution of the DJ continues, so does the designs of Odyssey DJ coffins. Introducing the new BLACK LABEL™ REMIXER™ GLIDE STYLE™ SERIES DJ coffins featuring a full width glide platform to place all your DJ remix gear. With digital vinyl software such as Serato, Traktor Scratch, and Ableton, more DJs have gone through the transition from beat mixer to full on remixer producer. Availability of so many affordable remixing tools to the DJ, such as midi keyboards and controllers to laptops and iPads, have grown to an ultimate high and Odyssey is there in the middle of it all providing these DJs the most functional DJ coffins yet with the REMIXER™ GLIDE STYLE™ SERIES. Standard Flight Zone® cases are also available. (pg.33)

MODEL	DIMENSIONS	WEIGHT	FITS
FZGSP10CDJWBL	42.5" x 10.63" x 21"	50 lbs.	10" Mixer and (2) CD/Digital Media Players
FZGSP12CDJWBL	45" x 10.63" x 21"	52 lbs.	12" Mixer and (2) CD Players/ Digital Media Players

FZGSPBM10WBL	47.25" x 10.5" x 24.25"	56 lbs.	10" Mixer and (2) Turntables in Battle Mode
FZGSPBM12WBL	49.5" x 10.5" x 24.5"	65 lbs.	12" Mixer and (2) Turntables in Battle Mode

\*These cases are not designed to transport laptops.

**Black Label**™ FOLD-OUT STAND



**FZF3336BL**

Our Black Label™ Flight Zone® collapsible table stands transform from folded flat to heavy-duty DJ stand in an instant. Use them for a home studio or have them set up on stage. These stands provide a clean, professional appearance that's easy to setup and teardown in addition to being easy-to-store and transport. Rugged hardware snaps all surfaces into place for added stability. Standard Flight Zone® cases are also available. (pg. 99)

MODEL	DIMENSIONS (UNFOLDED)	WEIGHT	BEST USED FOR:	
FZF1930BL	19" x 30" x 18.5"	26 lbs.	racks	<i>new</i>
FZF2636BL	26" x 36" x 18.5"	30 lbs.	coffins consoles	<i>new</i>
FZF3336BL	33" x 36" x 18.5"	33 lbs.	coffins consoles	
FZF5437TBL	54" x 37" x 18.5"	45 lbs.	coffins consoles, tabletop gear	<i>new</i>

**Black Label**™ GLIDE STYLE™ DIGITAL DJ CONTROLLER CASES



**FZGSVCI300GTBL**  
Holds a Vestax VCI-300



**FZGSVCM600GTBL**  
Holds a Vestax TR-1 / VCM-600 or M-Audio Xponent.



**FZGSRMXBL**  
Holds a Hercules RMX/STEEL, Numark Omni Control / Stealth MIDI controller

These Flight Zone® Black Label™ series cases have our patented and popular Glide Style™ laptop platform. Made specifically to house the most popular digital DJ controllers out in the market, these cases feature removable front panels and room behind and below the controller to store cables and other essentials. Each also features a convenient pullout tray great for placement of gear such as one of our compact keyboards (featured on pg. 96-97). Standard Flight Zone® cases are also available. (pg. 47)

MODEL	DIMENSIONS	WEIGHT	FITS
FZGSVCI300GTBL	20" x 8.5" x 16.5"	24 lbs.	Vestax VCI-300 DJ MIDI Controller (with pullout glide tray)
FZGSVCM600GTBL	20.5" x 9.25" x 17"	27 lbs.	Vestax TR-1/VCM-600/M-Audio Xponent DJ MIDI Controller (with pullout glide tray)
FZGSRMXBL	20" x 8.5" x 16.5"	29 lbs.	Hercules RMX/STEEL, Numark Omni Control / Stealth MIDI controller

\*These cases are not designed to transport laptops.

**BLACK LABEL** SERIES **NUMARK NS7 CASES** *NEW ARRIVAL*



Detachable NSF Plate also sold separately

•This case is not designed to transport a laptop.

**FZGSNS7WFXBL**

Features a top glide platform & bottom glide tray



Recessed Rollers for easy transportation

**FZNS7WBL**

**FZNS7WBL**

Protect your investment on the Numark NS7 controller for the Serato ITCH software with the well known quality of an Odyssey case. Each features room under and behind the NS7 controller area to store hard drives, cables, etc. The FZGSNS7WFX version features our patented "Glide Style™" full width platform with a NSF attachment plate that allows you to setup and use your laptop, FX controller, and other additional digital DJ gear just above the NS7 for easy access. Slide the platform back or forward to the right spot that's best for you. An additional pullout shelf and cable port hole just under your NS7 provides even more convenient placement of your gear, such as Odyssey's "CONTROL SL" Serato keyboard (not included). Both NS7 case models are also available in our standard Flight Zone® series (see pg. 42).

MODEL	DIMENSIONS	WEIGHT	TRAY
FZGSNS7WFXBL	36.75" x 11" x 22.5"	51 lbs.	17.5" W x 15"D
FZNS7WBL	32.75" x 9" x 21.5"	31 lbs.	N/A

**BLACK LABEL** SERIES **NUMARK MIXDECK CASES** *NEW ARRIVAL*



Recessed Rollers for easy transportation



**FZGSMIXDECKGTBL**

Features a top glide platform & bottom glide tray

**FZMIXDECKBL**



Recessed Rollers for easy transportation

MODEL	DIMENSIONS	WEIGHT	TRAY
FZGSMIXDECKGTBL	30.5" x 11.5" x 18.75"	39 lbs.	17.5"W x 15"D
FZMIXDECKBL	28.75" x 9.25" x 18.5"	25 lbs.	N/A

# IT'S MORE. IT'S LESS.



Introducing GX7, the newest model in the GX Series family. It's a brilliant combination of more power and less weight. It's everything you need in a power amplifier and none of the distraction and expense of the things you don't. And, like the rest of the #1-selling retail amplifier line in America<sup>1</sup>, the GX7 is backed with an industry-best 6-year warranty<sup>2</sup>.

Model	Watts per Channel*		Weight
	8Ω	4Ω	
GX3	300	425	27 lbs.
GX5	500	700	28 lbs.
<b>GX7</b>	<b>725</b>	<b>1000</b>	<b>17 lbs.</b>

\* 1kHz, 0.1% clipping

GX7 is assembled with care and pride at our headquarters in Costa Mesa, California.

<sup>1</sup> MI SalesTrak® 2010

<sup>2</sup> With online registration

[www.qscaudio.com/gx](http://www.qscaudio.com/gx)



©2010 QSC Audio Products, LLC. All rights reserved. QSC and the QSC logo are registered trademarks of QSC Audio Products, LLC in the U.S. Patent and Trademark office and other countries. GuardRail is a trademark of QSC Audio Products, LLC. MI SalesTrak is a registered trademark of Marketing Information Services, Inc. in the US Patent office.

## BLACK LABEL™ AMP RACKS

OPTIONAL



FZADP  
Available as an option for only non-wheeled FZ series models



FZAR16WBL



FZAR12WBL



FZAR08BL

These sturdy Black Label™ ATA Amp Racks incorporate dual rack rails (front and rear), heavy-duty rubber feet (non-wheeled versions), spring-loaded handles, and removable front and rear covers. Designed to protect and transport larger amps and other standard 19" rack mount gear.

- Internal Depth (Rail to Rail): 16.5"
- Internal Depth (Rail to Cover): 19.75"

MODEL	DIMENSIONS	WEIGHT	FITS
FZAR04BL	21.5" x 10.5" x 25.25"	23 lbs.	4U
FZAR06BL	21.5" x 13.5" x 25.25"	28 lbs.	6U
FZAR08BL	21.5" x 16.5" x 25.25"	36 lbs.	8U
FZAR12WBL	21.5" x 26.5" x 25.25"	67 lbs.	12U (dolly plate included)
FZAR16WBL	21.5" x 29.5" x 25.25"	74 lbs.	16U (dolly plate included)

# DN-MC6000

The **A1** of all-in-one controllers.



We're serious about our products, their build quality and how they perform, just like you are serious about your gigs. We believe you DJ to entertain, to have fun, and to make money. So why would you stake your business, your reputation, your performance and your compensation on an all-in-one toy?

Introducing the Denon DJ DN-MC6000 4ch. / 4-deck MIDI controller with USB Sound Card.

It won't physically print you money, but you get the idea.



VIRTUAL DJ



## BLACK LABEL™ COMBO RACKS



FZ1116WDLXBL

FZ1002BL

Our Black Label™ ATA Combo Racks give you the best of both worlds. Mount mixers, controllers on top for convenient access and all other essentials below. Includes top and front lids. The FZ1116WDLXBL version includes heavy-duty casters on a dolly plate (front casters feature sure stop brakes) and a lid that turns into a side mount tabletop that can be mounted on either side of the rack (table can hold approximately 200 lbs. evenly distributed) Standard Flight Zone® cases are also available. (pg.54)

- Interior Depth (rail to rail): 18.75"
- Interior Depth (rail to cover): 22.75"

MODEL	DIMENSIONS	WEIGHT	SLANT	VERT.
FZ1002BL	21.5" x 15.25" x 24"	35 lbs.	10U	2U
FZ1004BL	21.5" x 18.5" x 24"	38 lbs.	10U	4U
FZ1006BL	21.5" x 23" x 24"	41 lbs.	10U	6U
FZ1116WDLXBL	21.5" 44.25" x 26"	83 lbs.	11U	16U

## Black Label™ GLIDE STYLE™ COMBO RACKS



FZGS1002BL



FZGS1006BL



FRGS808BL

- Interior Depth (rail to back door): 20"
- Table may be mounted on either side (weight capacity: 200 lbs. evenly distributed)



FZGS1116WDLXBL

These Black Label™ Flight Zone® Glide Style™ combo racks feature our patented sliding laptop platform mounted above a 19" ATA case. Slide it forward to use your laptop. Slide it back to use the mixer section underneath. Also available in standard Flight Zone® Series. (pg. 55)

### Flight Ready Series:

MODEL	DIMENSIONS	WEIGHT	FITS
FRGS802BL	22" x 15.75" x 24"	21 lbs.	8U 2U
FRGS804BL	22" x 18.25" x 24"	33 lbs.	8U 4U
FRGS806BL	22" x 22" x 24"	36 lbs.	8U 6U
FRGS808BL	22" x 26" x 24"	38 lbs.	8U 8U

\*These cases are not designed to transport laptops.

### Flight Zone Series:

MODEL	DIMENSIONS	WEIGHT	FITS
FZGS1002BL	22.25" x 16.25" x 24"	41 lbs.	10u 2u
FZGS1004BL	22.25" x 19.75" x 24"	44 lbs.	10u 4u
FZGS1006BL	22.25" x 23.5" x 24"	48 lbs.	10u 6u
FZGS1116WDLXBL	22.25" x 45.25" x 28.5"	103 lbs.	11U 16U

\*This case is not designed to transport laptops.

## Black Label™ UTILITY CASE



FZUTWBL

Features include:

- Foam-line interior
- Hinged Lid
- Stacking Caster Plates
- Heavy-Duty Ball Corners
- Recessed Handles and Latches
- 4 Casters, 2 with brakes

MODEL	DIMENSIONS	INT. DIMENSIONS	WEIGHT
FZUTWBL	45.75" x 32" x 30.5"	43" x 23.5" x 27.75"	120 lbs.

## Black Label™ TRUCK PACKS



FZTP1WBL



FZTP2WBL

(Lids feature stacking caster plates)

Keep all your essential cables and gear safe and organized during transport with our Black Label™ truck pack cases. These cases feature a carpet-lined interior, recessed latches and handles, heavy-duty ball corners, hinged lids, and stacking caster plates. The FZTP1WBL features stacking caster plates for stacking two FZTP2WBL cases or another FZTP1WBL case on top.

MODEL	DIMENSIONS	INT. DIMENSIONS	WEIGHT
FZTP1WBL	47" x 31" x 24.5"	46" x 27.5" x 21.5"	90 lbs.
FZTP2WBL	23.5" x 35.5" x 23.5"	21.5" x 27.5" x 21.5"	59 lbs.

# Make A Statement That Screams Louder Than Cool!

Odyssey's Designer DJ™ Series cases offer a unique twist in design for DJ's who want to make a statement that screams louder than COOL. Available in Blue on Black or Red on Black, these cases are built tough to the exact standards and product protection as our Flight Ready® series of cases except all the hardware used in the build of these slick cases are powder coated and anodized in BLACK.

## DESIGNER DJ™ DENON CD/DIGITAL DJ COFFINS



FRDNX1200BKBLUE



FRDNX1200BKRED

MODEL	DIMENSIONS	WEIGHT	FITS
FRDNX1200BKBLUE	30.25" x 9.75" x 14.5"	28 lbs.	Denon DNX 100 or 120 mixer, (2) DNS1200/DNS1000 CD players
FRDNX1200BKRED	30.25" x 9.75" x 14.5"	28 lbs.	Denon DNX 100 or 120 mixer, (2) DNS1200/DNS1000 CD players

## DESIGNER DJ™ DJ MIXER CASES



FR10MIXBKBLUE



FR12MIXBKRED

MODEL	DIMENSIONS	WEIGHT	FITS
FR10MIXBKBLUE	21" x 9.38" x 12.75"	11 lbs.	most 10" mixers
FR10MIXBKRED	21" x 9.38" x 12.75"	11 lbs.	most 10" mixers
FR12MIXBKBLUE	14.5" x 8.75" x 20.5"	12 lbs.	most 12" mixers
FR12MIXBKRED	14.5" x 8.75" x 20.5"	12 lbs.	most 12" mixers

## DESIGNER DJ™ CD/DIGITAL MEDIA PLAYER CASES



FRCDJBKBLUE



\*width adjustment  
foam included

Large format CD/Digital DJ Coffins fit players such as:  
 American Audio Flex 100 MP3/  
 Radius1000/3000  
 Denon DN-S3700  
 Gemini CDJ210/600  
 Numark NDX800  
 Pioneer CDJ-1000MK3/800MK2/850  
 Stanton C-324



FRCDJBKRED

MODEL	DIMENSIONS	WEIGHT	FITS
FRCDJBKBLUE	15" x 9.5" x 20"	13 lbs.	Large format CD/Digital Media player
FRCDJBKRED	15" x 9.5" x 20"	13 lbs.	Large format CD/Digital Media player

*These cases are not made to fit the Pioneer CDJ-2000 or Numark V7 Players*

## DESIGNER DJ™ TURNTABLE CASES



FR1200BKBLUE



FR1200BKRED

MODEL	DIMENSIONS	WEIGHT	FITS
FR1200BKBLUE	20.25" x 9.25" x 17.25"	16 lbs.	1200 style turntables
FR1200BKRED	20.25" x 9.25" x 17.25"	16 lbs.	1200 style turntables

\*Our turntable cases can hold Numark, Stanton, as well as Technics 1200 style turntables.

## CD/DIGITAL DJ COFFINS • LARGE FORMAT

Our CD/Digital DJ Coffins hold two large format tabletop CD/Digital Media players and one 10", 12", or 19" mixer. These ATA Rolling Coffins feature rugged built-in rollers, heavy-duty spring-loaded handles, butterfly latches, stackable ball corners, and front access panels. Cabling is clean and easy through convenient access ports throughout.



Recessed Rollers for easy transportation



**FZ19CDJW**



**FZ10CDJW**



**FZ12CDJW**



\*width adjustment foam included

Large format CD/Digital DJ Coffins fit players such as:  
 American Audio Flex 100 MP3/Radius1000/3000

Denon DN-S3700  
 Gemini CDJ210/600  
 Numark NDX800/V7  
 Pioneer CDJ-1000MK3/2000  
 800MK2/850  
 Stanton C-324

### Flight Zone Series:

AVAILABLE IN 10", 12", 19" MIXER COMPARTMENT VERSIONS

MODEL	DIMENSIONS	WEIGHT	FITS
FZ10CDJW	34.5" x 9" x 18.5"	38 lbs.	10" mixer, (2) large format CD/Digital Players
FZ12CDJW	43" x 9.5" x 19"	40 lbs.	12" mixer, (2) large format CD/Digital Players
FZ19CDJW	48" x 9.5" x 19"	42 lbs.	19" mixer, (2) large format CD/Digital Players

### Flight Ready Series:

MODEL	DIMENSIONS	WEIGHT	FITS
FR10CDJWE	41" x 9.5" x 19.5"	34 lbs.	10" mixer, (2) large format CD/Digital Players
FR12CDJWE	43" x 9.5" x 19"	42 lbs.	12" mixer, (2) large format CD/Digital Players

\*Flight Ready cases are not made to fit the Denon V7 and Pioneer CDJ-2000 player.

## CD/DIGITAL DJ COFFINS • MEDIUM FORMAT



**FZ10CDiW**



\*width adjustment foam included



Recessed Rollers for easy transportation

Medium format CD/Digital DJ Coffins fit players such as:

American Audio CDI-300  
 Denon DN-S1200/S700  
 Gemini CFX-20  
 Numark ARC 3/Axis-4/Axis-9  
 NDX200/NDX400  
 CDJ-200/CD-J350/  
 CDJ-400  
 Stanton S-252/300  
 Vestax CDX-05MBK

### Flight Zone Series:

MODEL	DIMENSIONS	WEIGHT	FITS
FZ10CDiW	34.5" x 9" x 19"	37 lbs.	10" mixer, (2) medium format CD/Digital Media players
FZ12CDiW	36.5" x 9" x 19"	39 lbs.	12" mixer, (2) medium format CD/Digital Media players
FZ19CDiW	43" x 9.5" x 19.5"	43 lbs.	19" mixer, (2) medium format CD/Digital Media players

### Flight Ready Series:

MODEL	DIMENSIONS	WEIGHT	FITS
FR10CDiWE	34.5" x 9" x 19"	37 lbs.	10" mixer, (2) medium format CD/Digital Media players
FR12CDiWE	36.5" x 9" x 19"	39 lbs.	12" mixer, (2) medium format CD/Digital Media players

## DENON CD/DIGITAL DJ COFFIN



**FZDNX1200**



**FZDNX12000E**  
 (Econo version)

### Flight Zone Series:

MODEL	DIMENSIONS	WEIGHT	FITS
FZDNX1200	30.5" x 9.75" x 14."	24 lbs.	Denon DNX 100 or 120 mixer, (2) DNS1200/DNS1000 players
FZDNX12000E	22.75" x 7.5" x 15.25"	21 lbs.	Denon DNX 100 or 120 mixer, (2) DNS1200/DNS1000 players

Pioneer Dj

Perform Like A Pro



Pioneer  
**CDJ-350/DJM-350**

Digital Multi Player and 2-Channel DJ Performance Mixer

**CDJ-350**

- Multi format playback
- rekordbox™ music management software included
- BEAT Display function visually illustrates the beat position of a song and the playback point
- Auto Beat Loop function
- Auto BPM LOCK easily matches the tempo of songs by simply adjusting the speed to the Master BPM on each player
- Create PLAYLIST function
- DJ Software compatible

**DJM-350**

- Directly record to USB devices
- Enhance remixing capabilities with four types of effects
- Isolated 3-band equalizer
- Digital conversion for higher fidelity sound
- Selectable MIC/AUX channel

FOLLOW US ON: [facebook.com/pioneerdjusa](https://www.facebook.com/pioneerdjusa)  
[twitter.com/pioneerdj](https://twitter.com/pioneerdj)  
[youtube.com/pioneerdjglobal](https://www.youtube.com/pioneerdjglobal)

Shown with USB stick (not included).

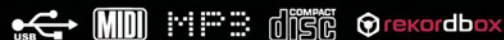

Check out the 350 system at your local Authorized Pioneer Dealer today  
[www.PioneerDJusa.com](http://www.PioneerDJusa.com)

**PIONEER CD/DIGITAL DJ COFFINS**

FZPi4400W



**Flight Zone Series:**

MODEL	DIMENSIONS	WEIGHT	FITS
FZPi4400W	31.25" x 9.5" x 17.5"	30 lbs.	Pioneer DJM-350/400 Mixer, (2) CDJ-350/400 Players

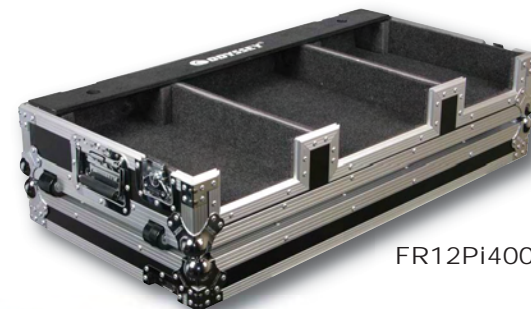

FR12Pi400WE

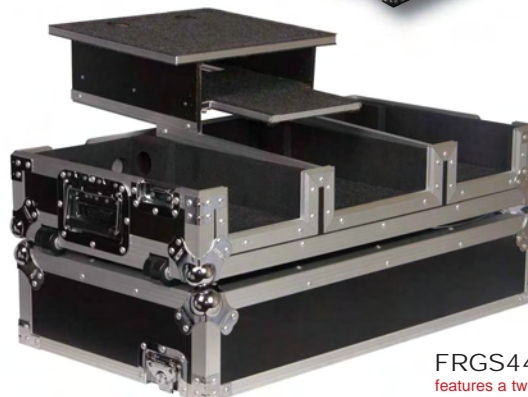

FRGS4400W  
 features a two tier gliding laptop platform



**Flight Ready Series:**

MODEL	DIMENSIONS	WEIGHT	FITS
FR10Pi400WE	34.5" x 9.75" x 19"	29 lbs.	10" mixer, (2) Pioneer CDJ-350/400 players
FR12Pi400WE	36.5" x 9.75" x 19"	35 lbs.	12" mixer, (2) Pioneer CDJ-350/400 players
FRGS4400W*	31.25" x 7.25" x 12.5"	39 lbs.	DJM-350/400 Mixer, (2) CDJ-350/400 Players *(not designed to transport laptops.)

## TURNTABLE DJ COFFINS

BATTLE STYLE TURNTABLE COFFINS



**Flight Zone Series:**

MODEL	DIMENSIONS	WEIGHT	FITS
FZBM10W	47" x 9" x 22.5"	53 lbs.	10" mixer, (2) 1200 style turntables in Battle position
FZBM12W	49" x 9" x 22.5"	56 lbs.	12" mixer, (2) 1200 style turntables in Battle position

\*Our turntable coffins can hold Numark, Stanton, as well as Technics 1200 style turntables!

FZBM12W

## STANDARD POSITION TURNTABLE COFFINS



FZDJ10W



FZDJ12W



FZDJ19W

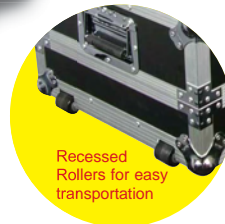

**Flight Zone Series:**

MODEL	DIMENSIONS	WEIGHT	FITS
FZDJ10W	46" x 8" x 22"	53 lbs.	10" mixer, (2) 1200 style turntables in Standard position
FZDJ12W	48" x 8" x 22"	55 lbs.	12" mixer, (2) 1200 style turntables in Standard position
FZDJ19W	61" x 8.25" x 20.7"	59 lbs.	19" mixer, (2) 1200 style turntables in Standard position

\*Our turntable coffins can hold Numark, Stanton, as well as Technics 1200 style turntables!

## GSX GLIDE STYLE™ CD/DIGITAL DJ COFFINS



FZGSX12CDJW



\*width adjustment foam included  
**Large format CD/Digital DJ Coffins fit players such as:**

- American Audio Flex 100 MP3/Radius1000/3000
- Denon DN-S3700
- Gemini CDJ210/600
- Numark NDX800/V7
- Pioneer CDJ-1000MK3/2000 800MK2/850
- Stanton C-324



Odyssey's GSX Glide Style™ Series DJ coffins feature the ability to safely store your laptop inside the actual laptop platform that sits right above the mixer compartment. To access the compartment, the top section slides open left and right and includes key locks for security allowing the DJ to take a break from the booth without having to worry about theft. Just another innovative design to the Glide Style™ case family. Also available in Black Label™ Series. (pg 10)

**Flight Zone Series:**

MODEL	DIMENSIONS	WEIGHT	FITS
FZGSX10CDJW	40.75" x 12.25" x 19.5"	51 lbs.	10" mixer, (2) large format CD/Digital Media players
FZGSX12CDJW	42.75" x 12.25" x 19.5"	52 lbs.	12" mixer, (2) large format CD/Digital Media players

\*These cases are not designed to transport laptops.

## GLIDE STYLE™ CD/DIGITAL DJ COFFINS

Our Glide Style™ Coffins hold two tabletop CD/Digital Media players, one mixer and a laptop. Each version features a slide-out shelf under the laptop platform for wireless mics, laptop interfaces, external hard drives, or other essential digital DJ gear. These ATA Rolling Coffins feature recessed rollers, heavy-duty, spring-loaded handles, recessed latches, stackable ball corners, and front access panels. Cabling is clean and easy through convenient access ports.

### LARGE FORMAT



Recessed Rollers for easy transportation



\*width adjustment foam included

Large format CD/Digital DJ Coffins fit players such as:

- American Audio Flex 100 MP3/Radius1000/3000
- Denon DN-S3700
- Gemini CDJ210/600
- Numark NDX800/V7
- Pioneer CDJ-1000MK3/2000 800MK2/850
- Stanton C-324

FZGS10CDJW

#### Flight Zone Series:

MODEL	DIMENSIONS	WEIGHT	FITS
FZGS10CDJW	40.5" x 12.5" x 19.5"	48 lbs.	10" mixer, (2) large format CD/Digital Media players
FZGS12CDJW	42.5" x 13" x 19"	49 lbs.	12" mixer, (2) large format CD/Digital Media players
FZGS19CDJW	50" x 12" x 20"	50 lbs.	19" mixer, (2) large format CD/Digital Media players

\*These cases are not designed to transport laptops.

### MEDIUM FORMAT



Recessed Rollers for easy transportation

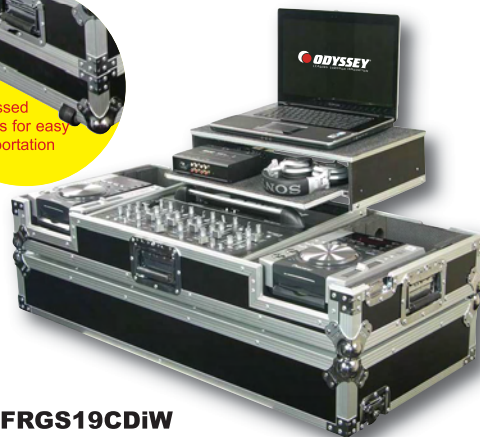

Medium format CD/Digital DJ Coffins fit players such as:

- American Audio CDI-300
- Denon DN-S1200/S700
- Gemini CFX-20
- Numark ARC 3/Axis-4/Axis-9 NDX200/NDX400
- Pioneer CDJ-200/CD-J350/CDJ-400
- Stanton S-252/300
- Vestax CDX-05MBK

\*width adjustment foam included

#### Flight Ready Series:

MODEL	DIMENSIONS	WEIGHT	FITS
FRGS10CDiW	19.5" x 12.50" x 34.5"	39 lbs.	10" mixer, (2) medium format CD/Digital Media players
FRGS12CDiW	37.25" x 12.5" x 19.75"	40 lbs.	12" mixer, (2) medium format CD/Digital Media players
FRGS19CDiW	43" x 12.5" x 19.75"	45 lbs.	19" mixer, (2) medium format CD/Digital Media players
FRGS4400W	31.25" x 17.25" x 12.5"	39 lbs.	Pioneer DJM-350/400 Mixer, (2) Pioneer CDJ350-400 Players

\*These cases are not designed to transport laptops.

FRGS19CDiW

## GLIDE STYLE™ TURNTABLE DJ COFFINS



Battle coffin features a platform that offsets to the right giving battle DJ's complete access to the left turntable arm.

FZGSBM12W  
(Battle Mode)



FZGSDJ10W  
(Standard Mode)



Recessed Rollers for easy transportation



FZGSDJ19W  
(Standard Mode)

Our Flight Zone® Glide Style™ DJ coffins are specially designed for digital DJs who prefer to manipulate their mixing software with turntables. Available in battle or standard turntable position and 10", 12", or 19" mixer setups. These cases feature our gliding dual platform with a pull out tray - Great for laptop interfaces and external hard drives as well as wireless mics and other essential DJ gear. Our turntable coffins can hold Numark, Stanton, and Technics Style Turntables.

#### Flight Zone Series:

MODEL	DIMENSIONS	WEIGHT	FITS
FZGSBM10W	45" x 12.5" x 22"	52 lbs.	10" mixer, (2) 1200 style turntables in battle mode
FZGSBM12W	47.5" x 12.5" x 22"	54 lbs.	12" mixer, (2) 1200 style turntables in battle mode
FZGSDJ10W	53.5" x 12.5" x 20"	54 lbs.	10" mixer, (2) 1200 style turntables in standard position
FZGSDJ12W	55.5" x 12.5" x 20"	58 lbs.	12" mixer, (2) 1200 style turntables in standard position
FZGSDJ19W	62.5" x 12.5" x 20"	61 lbs.	19" mixer, (2) 1200 style turntables in standard position

\*These cases are not designed to transport laptops.

# BRIDGE THE GAP BETWEEN DJING AND BEATMAKING

SERATO AND ABLETON COMBINE FORCES FOR A POWERFUL FUSION OF DJ AND PRODUCTION TOOLS, OPENING A WORLD OF OPPORTUNITIES FOR DJING, REMIXING AND LIVE PERFORMANCE



## THE BRIDGE

PERFECT YOUR MIXTAPES    PERFORM YOUR BEATS



FREE AUTHORIZATION  
FOR SCRATCH LIVE 2.1  
AND ABLETON 8.2 OWNERS  
[WWW.SERATO.COM/THEBRIDGE](http://WWW.SERATO.COM/THEBRIDGE)



## Remixer™ GLIDE STYLE™ SERIES DJ COFFIN

As the evolution of the DJ continues, so does the designs of Odyssey DJ coffins. Introducing the new REMIXER™ GLIDE STYLE™ SERIES DJ coffins featuring a full width glide platform to place all your DJ remix gear. With digital vinyl software such as Serato, Traktor Scratch, and Ableton, more DJs have gone through the transition from beat mixer turntablist to full on remixer producer. Availability of so many affordable remixing tools to the DJ, such as midi keyboards and controllers to laptops and iPADS, have grown to an ultimate high and Odyssey is there in the middle of it all providing these DJs the most functional DJ coffins yet with the REMIXER™ GLIDE STYLE™ SERIES. Also available in Black Label™ Series. (pg 11)



\*width adjustment foam included

Large format CD/Digital DJ Coffins fit players such as:

- American Audio Flex 100 MP3/Radius1000/3000
- Denon DN-S3700
- Gemini CDJ210/600
- Numark NDX800/7
- Pioneer CDJ-1000MK3/2000 800MK2/850
- Stanton C-324



FZGSP19CDJW



Recessed Rollers for easy transportation



FZGSP10CDJW



FZGSBM12W

\*Our turntable coffins can hold Numark, Stanton, as well as Technics 1200 style turntables!

MODEL	DIMENSIONS	WEIGHT	FITS
FZGSP10CDJW	42.5" x 10.63" x 21"	50 lbs.	10" Mixer and (2) CD/Digital Media Players <b>NEW</b>
FZGSP12CDJW	45" x 10.63" x 21"	52 lbs.	12" Mixer and (2) CD/Digital Media Players <b>NEW</b>
FZGSP19CDJW	50.5" x 10.63" x 21"	56 lbs.	19" Rackmount mixers (2) CD/Digital Media Players <b>NEW</b>
FZGSPBM10W	47.25" x 10.5" x 24.25"	56 lbs.	10" Mixer and (2) Turntable in Battle Mode <b>NEW</b>
FZGSPBM12W	49.5" x 10.5" x 24.5"	65 lbs.	12" Mixer and (2) Turntable in Battle Mode <b>NEW</b>

\*These cases are not designed to transport laptops.

## CD/DVD/VIDEO GAME DISC & LP/UTILITY CASES



**FZCD320**



**FZCD480**



**FZ45120**

Dividers not included

### Flight Ready CD Cases:

MODEL	DIMENSIONS	WEIGHT	FITS
FRCD250E	12.75" x 9.4" x 21"	11 lbs.	approx. 250 viewpack CDs, 80 jewel cases <b>NEW</b>

### Flight Zone LP Cases:

MODEL	DIMENSIONS	WEIGHT	FITS
FZ45120	20" x 11" x 11"	12 lbs.	approx. 120 45's
FZLP80	15" x 15" x 15"	22 lbs.	approx. 80 LPs
FZLP120HW	22" x 17" x 18"	32 lbs.	approx. 120 LPs (w/recessed rollers and pullout handle)

### Flight Zone CD Cases:

MODEL	DIMENSIONS	WEIGHT	FITS
FZCD1500W	62.75" X 9" X 22"	60 lbs.	approx. 1500 viewpack CDs, 340 jewel cases <b>NEW</b> w/ recessed rollers
FZCD320	26" x 9" x 16"	19 lbs.	approx. 320 viewpack CDs, 106 jewel cases
FZCD480	39" x 9" x 16.5"	36 lbs.	approx. 480 viewpack CDs, 160 jewel cases
FZCD720W	47" x 8.5" x 19"	45 lbs.	approx. 720 viewpack CDs, 240 jewel cases with recessed rollers and pull out handle



**FZLP80**

## CD/DIGITAL MEDIA PLAYER CASES

Medium format CD/Digital DJ  
Coffins fit players such as:

American Audio CDI-300  
Denon DN-S1200/S700  
Gemini CFX-20  
Numark ARC 3/Axis-4/Axis-9  
NDX200/NDX400  
Pioneer CDJ-200/CD-J350/  
CDJ-400  
S-252/300  
Stanton Vestax CDX-05MBK

**NEW**



**FZCDJDIA**



**FZCDJ**

Large format CD/Digital  
media case



**FZCDI**

Medium format CD/Digital  
media case



**FZDVJ1000**

Pioneer DVJ1000 Player Case

Large format CD/Digital DJ Coffins  
fit players such as:

American Audio Flex 100 MP3/  
Radius1000/3000  
Denon DN-S3700  
Gemini CDJ210/600  
Numark NDX800/V7  
Pioneer CDJ-1000MK3/2000  
800MK2/850  
Stanton C-324

### Flight Zone Series:

MODEL	DIMENSIONS	WEIGHT	FITS
FZCDI	18" x 9" x 12"	13 lbs.	medium format CD/Digital Media player
FZCDJ	15" x 9" x 19"	17 lbs.	large format CD/Digital Media player
FZCDJDIA	15" x 9" x 19"	17 lbs.	large format CD/Digital Media player <b>NEW</b>
FZDVJ1000	15" x 9" x 21"	18 lbs.	DVJ1000

### Flight Ready Series:

MODEL	DIMENSIONS	WEIGHT	FITS
FRCDIE	11.75" x 9" x 18.5"	10 lbs.	medium format CD/Digital Media player
FRCDJE*	14.75" x 8.25" x 19"	11 lbs.	large format CD/Digital Media player

\* (not for Pioneer CDJ2000 or Numark V7)

## PIONEER CD/DIGITAL MEDIA PLAYER CASES



**FRPi1000E**

### Flight Ready Series:

MODEL	DIMENSIONS	WEIGHT	FITS
FRPi1000E	14.75" x 8.25" x 19"	13 lbs.	Pioneer CDJ-1000 player
FRPi400E	11.75" x 8" x 18.5"	11 lbs.	Pioneer CDJ-350/CDJ-400 player



**FRPi400E**



\*width adjustment foam  
included

# roll the beats



Dicer puts Serato's cue-point and looping control exactly where it should be: on the decks. It can trigger samples, effects and even navigate your track library. Dicer was designed in conjunction with Serato Scratch Live and works with all major DJ software including Traktor Scratch Pro.

DICER COMES IN PAIRS!

2x



CARRY CASE NOW AVAILABLE!



DIGITAL DJ SOLUTIONS FROM



For further information: (310) 322 5500

www.novationmusic.com/dicer

## TURNTABLE CASES



FR1200E  
Flight Ready Series



FTTDIA



FZ1200  
Flight Zone Series



Our turntable cases can hold Numark, Stanton, as well as Technics 1200 style turntables!

MODEL	DIMENSIONS	WEIGHT
FR1200E	20.25" x 9.25" x 17.25"	17 lbs.
FTTDIA	22" x 9" x 18"	18 lbs.
FTTDIAII	22.25" x 9.5" x 18"	20 lbs.
FZ1200	21.5" x 9.5" x 21.5"	20 lbs.

with lower storage/ventilation section **NEW**

Also available:

## FLIGHT STYLE TURNTABLE CASES



FTTXBLK



FTTX\*

\*Available in black, red, or blue

• 21" x 9.5" x 17.5", 20 lbs.

• FTTX cases can hold Numark, Stanton, as well as Technics 1200 style turntables!

# GAME ON

Two computers, two USB ports, four decks and a range of effects.

Rane and Serato welcome the ultimate club mixer experience. Introducing the first Scratch Live compatible DJ mixer that allows two computers to be connected simultaneously. Using two USB ports, the new Rane SIXTY-EIGHT mixer lets two DJs play Scratch Live at the same time, allowing seamless handover from one DJ to another. You can also control up to four decks with a single laptop.

Armed with studio-grade phono preamps and S/PDIF inputs to provide a blend of analog and digital audio sources like never before, the Rane SIXTY-EIGHT features easy to use internal digital effects, and direct control of over 30 Scratch Live library, cue and loop functions.

Serato adds four new Display Modes into Scratch Live 2.0. These new screen layouts introduce 2, 3 or 4 deck control, each with clean design and your choice of Library Views. Additional tools can be activated in Scratch Live that give you an expanded view and instant control of a range of free plug-ins including the SP-6 Sample Player, brand new Serato DJ FX and direct access to Ableton Live via "The Bridge". You can also add the optional Serato Video-SL plug-in to bring exciting visuals into your performance.

You now have access to more tracks and effects than ever before with the clean and simple control that makes Scratch Live the number one choice for professional DJs.

The Rane SIXTY-EIGHT mixer with Serato Scratch Live 2.0



SCRATCHLIVE | serato || RANE

WWW.SCRATCHLIVE.NET • WWW.SERATO.COM • WWW.RANE.COM

## DJ MIXER CASES

Travel in style and security with our ATA DJ Mixer Cases. They fit most popular DJ mixer sizes and feature a high quality foam-lined interior. The 10" version features a removable front access panel and fits mixers 8.75" to 10.75" wide, up to 15" deep, and 3" tall. The 12" version features a slight slant to angle the back of the mixer up and fits mixers 12.25" wide, up to 14.25" deep and 3" tall. The 19" version has up to 8 spaces for gear 4.5" to 6.125" tall (base to peak). Also available in Black Lable™ Series. (pg 8).



FZ19MIX



FZ12MIX

**NEW**



FZ10MIXDIA



FZ10MIX

### Flight Zone Series:

MODEL	DIMENSIONS	WEIGHT	FITS
FZ10MIX	13" x 9.5" x 21.5"	18 lbs.	most 10" mixers
FZ10MIXDIA	13" x 9.5" x 21.5"	18 lbs.	most 10" mixers <b>NEW</b>
FZ12MIX	15.5" x 9.5" x 19.5"	19 lbs.	most 12" mixers
FZ12MIXDIA	15.5" x 9.5" x 19.5"	19 lbs.	most 12" mixers <b>NEW</b>
FZ19MIX	21.5" x 8.5" x 17"	20 lbs.	10u rackmount 19" mixer

### Flight Ready Series:

MODEL	DIMENSIONS	WEIGHT	FITS
FR10MIXE	12.75" x 9.38" x 21"	11 lbs.	most 10" Mixers
FR12MIXE	14.5" x 9.38" x 20.5"	12 lbs.	most 12" Mixers

## GLIDE STYLE™ DJ MIXER CASES

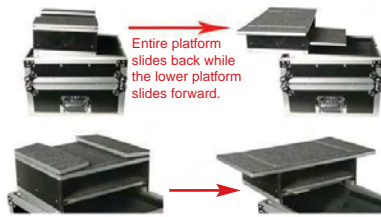

Unfolding wings expand the top platform of the FZGS10MIX and FZGS12MIX



Rear cable well



FZGS110  
Single tier platform & 19", 10u rack

Our family of Patented Glide Style™ Mixer cases are the most sought after DJ mixer cases in the industry. Our 10" & 12" mixer versions feature our dual sliding laptop platform mounted up above the mixer compartment and are designed with extra deep cable well area for plenty of room for power supplies as well as cables. The FZGS10MIX & FZGS12MIX feature unfolding wings that expand the top width of the laptop platform, and the FZGS10 features a single tier glide

### Flight Zone Series

MODEL	DIMENSIONS	WEIGHT	FITS
FZGS10MIX	20.5" x 13" x 16.25"	32 lbs.	most 10" Mixers
FZGS12MIX	21.25 x 13" x 14.75"	33 lbs.	most 12" Mixers
FZGS10	22.25" x 12" x 20"	32 lbs.	most 19" Mixers (10u Rack)
FZGS10CP	20.5" x 13" x 16.25"	31 lbs.	most 10" Mixers
FZGS12CP	21.25" x 13" x 14.75"	32 lbs.	most 12" Mixers

\*These cases are not designed to transport laptops.

## CD/DIGITAL MEDIA MIXER COMBO RACKS



Top Section fits the following:  
Gemini CDM-3200/3610/3700G  
Gemini CDM P6000  
Numark CD MIX 1, 2, 3,  
Numark iCDMIX 2 & 3  
Numark KMX02  
Stanton CM205

### Flight Ready Series

MODEL	DIMENSIONS	WEIGHT	VERT. SPACE
FRNR1904	21.5" x 16.25" x 19"	32 lbs.	4U
FRGSNR1904	22.25" x 17.25" x 19"	37 lbs.	4U

\*This case is not designed to transport laptops.

## CD/DIGITAL MEDIA MIXER CASES



FZCDM and FRCDM fit the following:  
Gemini CDM-3200/3610/3700G  
Gemini CDM P6000  
Numark CD MIX 1, 2, 3,  
Numark iCDMIX 2 & 3  
Numark KMX02  
Stanton CM205



MODEL	DIMENSIONS	WEIGHT
FZCDM	21.5" x 10.25" x 15.5"	10 lbs.
FRCDM	21.5" x 10.24" x 14.875"	15 lbs.

# NUMARK HDMIX CD/DIGITAL MEDIA PLAYER MIXER CASES

**FZGSHDMIXGT**  
 (Keyboard optional)

\*This case is not designed to transport your laptops.



**FZHDMIX**

The FZHDMIX and FZGSHDMIX are made specifically to house the Numark HDMIX mixing station, these cases feature removable front covers for easy access to the front loading CD tray and hard drive port as well as enough room behind the HDMIX to store cables and other miscellaneous essentials.

**Flight Zone Series:**

MODEL	DIMENSIONS	WEIGHT	FITS
FZHDMIX	21" x 8.5" x 18"	21 lbs.	Numark HDMIX CD/Media player
FZGSHDMIXGT	23" x 11.25" x 18.5"	38 lbs.	Numark HDMIX CD/Media player (with pullout glide tray)

# NUMARK NS7 CASES



**FZGSNS7WFX**

Featuring a Top Glide Platform & Bottom Glide Tray. (This case is not designed to transport laptops.)



**NEW ARRIVAL**



Detachable FX Plate also sold separately



**FZNS7W**



Recessed Rollers for easy transportation

Protect your investment on the Numark NS7 controller for the Serato ITCH software with the well known quality of an Odyssey case. Each features room under and behind the NS7 controller area to store hard drives, cables, etc. The FZGSNS7WFX version features our patented "Glide Style™" full width platform with a NSFX attachment plate that allows you to setup and use your laptop, FX controller, and other additional digital DJ gear just above the NS7 for easy access. Slide the platform back or forward to the right spot that's best for you. An additional pullout shelf and cable port hole just under your NS7 provides even more convenient placement of your gear, such as Odyssey's "CONTROLSL" Serato keyboard (not included). Both NS7 case models are also available in our Black Label™ series (see pg. 14).

**Flight Zone Series:**

MODEL	DIMENSIONS	WEIGHT	TRAY
FZGSNS7WFX	36.75" x 11" x 22.5"	51 lbs	17.5"W x 15"D <b>NEW</b>
FZNS7W	32.75" x 9" x 21.5"	31 lbs	N/A <b>NEW</b>

# MEET MIXDECK.

THE HOTTEST PIECE OF DJ GEAR ANYWHERE.



Today's DJ needs to be able to handle all kinds of media - CDs, MP3 CDs, USB flash drives, iPod®, laptops, and a variety of analog sources. That's why Numark created MIXDECK, a complete DJ system that handles any and every type of media thrown at it with ease. This DJ performance powerhouse lets you mix and perform with your music using the two-turntables-and-a-mixer layout that you know and love, while also taking advantage of the included Traktor Numark Edition software from Native Instruments, the state of the art in digital DJ software.

**Mixdeck.** It's all you need.

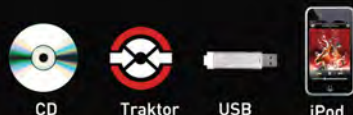

PLAY ALL MEDIA

**Numark**  
NUMARK.COM

\*iPod not included. iPod is a trademark of Apple, Inc., in the U.S. and other countries.

INCLUDES FULLY INTEGRATED DJ SOFTWARE  
**TRAKTOR**  
Numark EDITION  
Traktor is a trademark of Native Instruments

## NUMARK MIXDECK CASES



**Features:**

- Rear and Bottom Cable port perfect for cable management
- Exclusive Patent Pending Bevel Foam Interior
- Recessed Handle and Latches
- Heavy-Duty Ball Corners
- Storage / Ventilation Pits
- Bottom Rubber Feet

### FZGSMIXDECKGT

Features a Top Glide Platform & Bottom Glide Tray.  
(This case is not designed to transport laptops.)

**NEW**  
ARRIVAL



Recessed  
Rollers for easy  
transportation

### FZMIXDECK

**Flight Zone Series:**

MODEL	DIMENSIONS	WEIGHT	TRAY
FZGSMIXDECKGT	30.5" x 11.5" x 18.75"	39 lbs.	17.5" W x 15"D
FZMIXDECK	28.75" x 9.25" x 18.5"	25 lbs.	N/A

**NEW**  
**NEW**

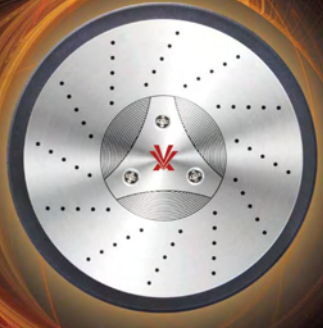

# EYE OF THE STORM

Typhoon is an affordable all-in-one Digital DJ Controller System featuring professional platters using Vestax's exclusive VCI-300 technology and now includes *Virtual DJ software for free!*

## Typhoon

Get your hands on the most incredible Scratch and Mix control technology on the planet! Loaded with integrated effects control, Vestax's heralded cross-fader, loop control, and the coolest platter covers available, Typhoon puts you in the Eye of the Storm. Contact your Vestax Dealer today to start your own Typhoon!



Includes **Virtual DJ with Custom Typhoon Graphics.**

High-res, Touch-sensitive, Dual-action Platters for scratching and mixing.

Exclusive Crossfader Technology. Proven in countless club & stadium performances.

Integrated Effects Controllers with independent filter switches offering infinite creative possibilities!

**VIRTUAL DJ LIMITED EDITION**

music & sound **AM & S**

**Vestax**  
INFO@VESTAXUSA.COM WWW.VESTAX.COM

## DIGITAL DJ CONTROLLER CASES



**FZGSRMX**

Holds a Hercules RMX / STEEL or Numark Omni Control / Stealth **NEW**



**NEW**



**FZGSVCI300FXGT**

Holds a Vestax VCI-300 and VFX-1



**FRRMX**

Flight Ready® case for Hercules RMX/STEEL Midi DJ Controller



**NEW**

**FZGSXONEDX**

Holds a Allen & Heath Xone:DX



**FZGSVCM600GT**

Holds a Vestax TR-1 / VCM-600 or M-Audio Xponent.

Odyssey introduces these superb editions to the Flight Zone® series. Each has the patented and popular Glide Style™ laptop platform. Made specifically to house the most popular digital controllers out in the market, these cases feature removable front panels and room behind and below the controller to store cables and other essentials. Visit our website for all available models.

### FLIGHT ZONE

MODEL	DIMENSIONS	WEIGHT	FITS
FZGSRMX	20.5" x 8.25" 16.25"	29 lbs.	Hercules RMX/STEEL, Numark Omni Control / Stealth MIDI controller
FZGSTKS4	24.25" x 8.75" x 18.25"	22 lbs	Traktor Kontrol S4/American Audio VMS4 DJ MIDI Controllers <b>NEW</b>
FZGSVCI300	20" x 8.5" x 16.5"	29 lbs.	Vestax VCI300 DJ MIDI Controller
FZGSVCI300GT	20" x 8.5" x 16.5"	24 lbs.	Vestax VCI300 DJ MIDI Controller with pull out tray and backlit keyboard <b>NEW</b>
FZGSVCI300FXGT	20" x 8.5" x 16.5"	24 lbs.	Vestax VCI300 DJ MIDI Controller with pull out tray and backlit keyboard <b>NEW</b>
FZGSVCM600	23.25" x 8" x 17.5"	22 lbs.	Vestax TR-1/VCM-600/M-Audio Xponent DJ MIDI Controller
FZGSVCM600GT	23" x 7.75" x 18"	24 lbs.	Vestax TR-1/VCM-600/M-Audio Xponent DJ MIDI Controller (with pullout glide tray)
FZGSXONEDX	19.88" x 9.25" x 9.25"	23 lbs.	Allen & HeathXone:DX DJ MIDI Controller <b>NEW</b>
FRRMX	19.75" x 8"H x 16"	14 lbs.	Hercules RMX/STEEL Midi DJ Controller <b>NEW</b>
FRVCI300	19.38" x 7"H x 17.5"	11 lbs.	Vestax VCI300 DJ Midi Controller <b>NEW</b>

\*These cases are not designed to transport laptops.  
**FLIGHT READY**

**AKAI** professional **APC40**

**“I'M HOOKED”**

- PETE TOWNSHEND

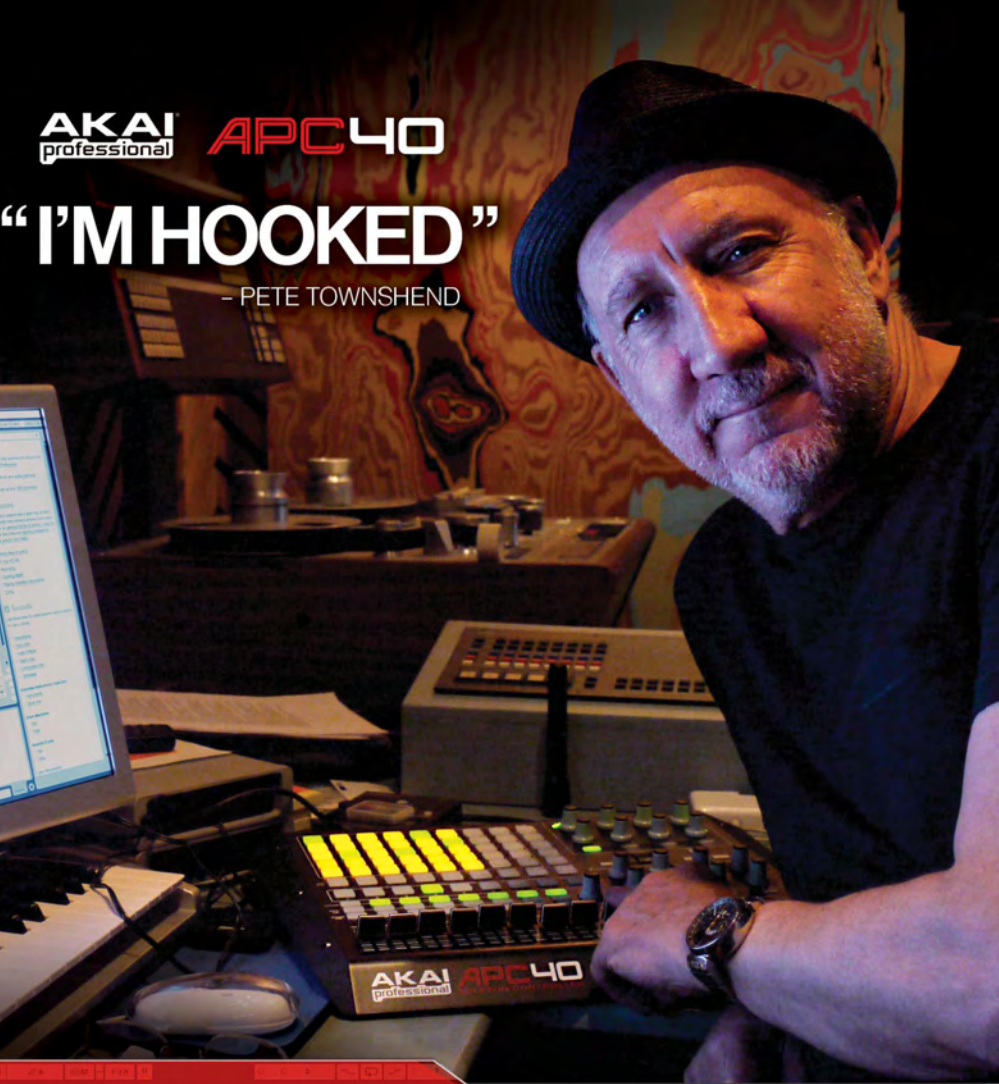

# APC40

ABLETON CONTROLLER

"The APC40 is the most powerful new tool for the stage and studio that I've seen in the last ten years. It makes creating loops and rhythmic scenes, constantly changing and evolving, so easy. It's completely intuitive, and everything is right under my fingers."

This interface, loaded with drum loops, makes you feel like that kid in Santana playing at Woodstock in 1969. It's a revolution, but this time the only drug is the APC40. I'm hooked."

- PETE TOWNSHEND



## AKAI APC-40 DIGITAL CONTROLLER CASE



### FZAPC40

The right case with the perfect fit, Odyssey's FZAPC40 is the latest in a rich history of innovative case designs, engineered specifically for the hottest Akai Product on the market today!

Our case comes foamed lined all around its interior, insuring that secure fit. Also featuring lockable latches, room for the power supply, and a compact design making it the only choice when it comes to protecting your future. So when you're ready, roll with the best, Odyssey... leading through innovation.

*Flight Zone Series:*

MODEL	DIMENSIONS	WEIGHT	FITS
FZAPC40	19" x 4.75" x 18"	11 lbs.	Akai APC-40

# RUN THE SHOW



**XLS** Take command of center stage with Crown's new XLS amplifiers. The high-performance class-D amplifier combined with its integrated PureBand™ Crossover System deliver unmatched performance and sound; while its multiple inputs let you plug in anything you want. Peak™ Limiters effortlessly protect your speaker investment, and at 12 pounds moving from show to show is a breeze. Powerful, flexible, portable, and reliable – **RUN THE SHOW** with a power amplifier designed to play hard all night long.

To learn more, visit [crownaudio.com](http://crownaudio.com).



# XLS



©2010 Crown International

## SHOCK MOUNT RACKS



**SHOCK PROTECTION!**



Specifically designed for touring professionals and seasoned sound engineers, Shock Mount Racks provide the ultimate in protection for sensitive gear as well as heavy loads. Each internal rack is surrounded with thick high-density EVA foam and features front and rear rack rails, heavy-duty recessed chrome-plated steel hardware spring-loaded handles, and 3/8" ply laminate shells. Specifically designed to withstand the abuse of life on the road. Available in 5 sizes.

**Flight Zone Series**

MODEL	DIMENSIONS	WEIGHT	SPACE
FZS02	24" x 8.5" x 26.5"	42 lbs.	2U
FZS04	24" x 12" x 26.5"	47 lbs.	4U
FZS06	24" x 15.5" x 26.5"	52 lbs.	6U
FZS08	24" x 19" x 26.5"	57 lbs.	8U
FZS12W	24" x 32" x 26.5"	67 lbs.	12U

# AMP RACKS



FZAR20W

*Dolly plate included in "W" models*



FZAR4



FZAR10

These sturdy, ATA Amp Racks incorporate dual rack rails (front and rear), heavy-duty rubber feet (non-wheeled versions), spring-loaded handles, and removable front and rear covers. Designed to protect and transport larger amps and other standard 19" rackmount gear.

- Internal Depth (Rail to Rail): 16.5"
- Internal Depth (Rail to Cover): 19.75"

### Flight Zone Series

MODEL	DIMENSIONS	WEIGHT	SPACES
FZAR2	21.5" x 7.5" x 25.25"	18 lbs.	2U
FZAR4	21.5" x 10.5" x 25.25"	23 lbs.	4U
FZAR6	21.5" x 13.5" x 25.25"	28 lbs.	6U
FZAR8	21.5" x 16.5" x 25.25"	36 lbs.	8U
FZAR10	21.5" x 19.5" x 25.25"	44 lbs.	10U
FZAR12	21.5" x 22.5" x 25.25"	52 lbs.	12U
FZAR12W	21.5" x 26.5" x 25.25"	67 lbs.	12U (dolly plate included)
FZAR16	21.5" x 25.5" x 25.25"	59 lbs.	16U
FZAR16W	21.5" x 29.5" x 25.25"	74 lbs.	16U (dolly plate included)
FZAR20W	21.5" x 37.5" x 25.25"	85 lbs.	20U (dolly plate included)

### Flight Ready Series

MODEL	DIMENSIONS	WEIGHT	SPACES
FRAR2E	21.25" x 5.5" x 23.75"	17 lbs.	2U
FRAR4E	21.25" x 9.25" x 23.75"	19 lbs.	4U
FRAR6E	21.25" x 12.5" x 23.75"	21 lbs.	6U
FRAR8E	21.25" x 15.75" x 23.75"	27 lbs.	8U
FR16WE	21.25" x 34.5" x 23.75"	52 lbs.	16U (dolly plate included)

### OPTIONAL



FZADP  
Available as an option for only non-wheeled FZ series models

# SPACE SAVER™ AMP RACKS & COMBO RACKS



Ships flat



Slide in side panels



Fasten your screws in place



Step 3

Attach the dolly plate



Ready to Go!

### Features:

- Heavy-duty ball corners
- Recessed Latches and handles
- Aluminum tongue and groove frames to insure proper door fit
- Heavy-duty 4" casters (2 w/brakes)
- 17" interior body depth (rail to rail)
- 3" Covers
- Front and back rack rails



FZSRPAR16W



FZSRP1116W

### Flight Zone Series Amp Racks

MODEL	DIMENSIONS	INT. DEPTH (Rail to rail)	WEIGHT	VERT.
FZSRPAR12W	21.5" x 26.5" x 25.25"	17"	74 lbs.	12U
FZSRPAR16W	21.5" x 29.5" x 25.25"	17"	93 lbs.	16U
FZSRPAR20W	21.5" x 37.5" x 25.25"	17"	122 lbs.	20U

### Flight Zone Series Combo Racks

MODEL	DIMENSIONS	INT. DEPTH (Rail to rail)	WEIGHT	SLANT	VERT.
FZSRP1112W	21.5" x 37.25" x 28.5"	17"	78 lbs.	11U	12U
FZSRP1116W	21.5" x 45" x 28.5"	17"	96 lbs.	11U	16U

## COMBO RACKS

Our ATA Combo Racks give you the best of both worlds. Mount mixers and controllers on top for convenient access and all other essentials below. "W" versions feature heavy-duty casters on a dolly plate (front casters feature sure stop brakes) while the "DLX" (versions I and II) feature lids that turn into side mount workstations.

### FZ1116WDLX-II

Features dual side tables



Dolly Plate included on "W" models

FZ1116W

FZ1116WDLX

### Flight Zone Series

MODEL	DIMENSIONS	WEIGHT	SLANT	VERT.
FZ1002	21.5" x 15" x 24"	37 lbs.	10U	2U
FZ1004	21.5" x 18.5" x 24"	40 lbs.	10U	4U
FZ1006	21.5" x 23" x 24"	43 lbs.	10U	6U
FZ1008	21.5" x 25" x 24"	46 lbs.	10U	8U
FZ1012	21.5" x 31" x 24"	56 lbs.	10U	12U
FZ1014W	21.5" x 34" x 24"	66 lbs.	10U	14U
FZ1016W	21.5" x 44" x 24"	75 lbs.	10U	16U
FZ1108	21.5" x 25" x 24"	50 lbs.	11U	8U
FZ1112W	21.5" x 37.25" x 28"	75 lbs.	11U	12U
FZ1112WDLX	21.5" x 37.25" x 28"	83 lbs.	11U	12U
FZ1116W	21.5" x 45" x 28.5"	85 lbs.	11U	16U
FZ1116WDLX	21.5" x 44.25" x 26"	85 lbs.	11U	16U
FZ1116WDLXII	21.5" x 45" x 28"	95 lbs.	11U	16U
FZ1214WDLX-II	21.5" x 41" x 31.25"	100 lbs.	12U	14U
FZ1316W	21.5" x 45" x 28.5"	101 lbs.	13U	16U
FZ1316WDLX	21.5" x 45" x 28.5"	108 lbs.	13U	16U
FZ1316WDLX-II	21.5" x 44.75" x 33.5"	104 lbs.	13U	16U



FZ1002

OPTIONAL



### Flight Ready Series

MODEL	DIMENSIONS	WEIGHT	SLANT	VERT.
FR1002	21" x 14" x 22.5"	27 lbs.	10U	2U
FR1004	22.75" x 18.25" x 21"	30 lbs.	10U	4U
FR1006	23" x 22" x 21.25"	33 lbs.	10U	6U
FR1016W	21" x 39.75" x 23.25"	65 lbs.	10U	16U

FZWMP  
Available as an option for non-wheeled FZ series models with 10u top slant racks

## GLIDE STYLE™ COMBO RACKS

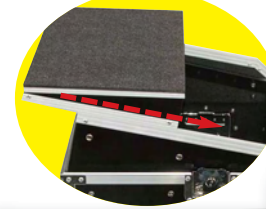

Dolly plate included in "W" models

30" HIGH PLUS 3" FOR LID

FZGS1116WDLX

FZGS1214WDLX-II

FZGS1004

Our Glide Style Combos feature our patented sliding laptop platform mounted above a 19" slanted rack mount section. At your gig, set your laptop on the carpeted surface, plug in and you're ready to go. Slide it forward to use your laptop. Slide it back to use the mixer section underneath. Keep your laptop close and safe on a sturdy new Glide Style™ Combo case.

### Flight Zone Series

MODEL	DIMENSIONS	WEIGHT	SLANT	VERT.
FZGS1002	23" x 16.25" x 24.5"	46 lbs.	10U	2U
FZGS1004	22.25" x 18.5" x 23.75"	44 lbs.	10U	4U
FZGS1304	22.25" x 21" x 28.5"	54 lbs.	13U	4U
FZGS1116W	22" x 45.25" x 28.25"	92 lbs.	11U	16U
FZGS1116WDLX	22.25" x 45.25" x 28.5"	103 lbs.	11U	16U
FZGS1214WDLX-II	22" x 45" x 31.25"	115 lbs.	12U	14U
FZGS1316WDLX	22.25" x 48.5" x 28.5"	111 lbs.	13U	16U

\*These cases are not designed to transport laptops.

### Flight Ready Series

MODEL	DIMENSIONS	WEIGHT	SLANT	VERT.
FRGS802	22" x 15.75" x 23"	21 lbs.	8U	2U
FRGS804	22" x 18.25" x 23"	33 lbs.	8U	4U
FRGS806	22" x 22" x 23"	37 lbs.	8U	6U
FRGS1016WDLX	22" x 44.5" x 23"	77 lbs.	1U	16U

\*These cases are not designed to transport laptops.

## EFFECTS RACKS

**FZER2**

 12.38" rail to rail  
 15.88" rail to cover

**FZER6**

 12.38" rail to rail  
 15.88" rail to cover

**FZER8HW**

 Convenient  
 pull out handle

**FZER4HW**

 Recessed rollers for  
 easy transportation

Our ATA Effects Racks feature dual rack rails (front and rear), heavy-duty steel ball corners, spring-loaded handles, and removable front and rear covers. Built to last under rigorous transporting. Our Rolling Racks feature low profile, super-strong recessed rollers, and a pull-out handle for superior convenience. These sturdy ATA cases accommodate all standard 19" rackmount equipment and feature front and back rails.

### Flight Zone Series

MODEL	DIMENSIONS	WEIGHT	SPACES
FZER2	21.5" x 5.5" x 21.25"	17 lbs.	2U
FZER4	21.5" x 9" x 21.25"	26 lbs.	4U
FZER4HW	21.5" x 11" x 21.25"	34 lbs.	4U
FZER6	21.5" x 12.75" x 21.25"	28 lbs.	6U
FZER6HW	21.5" x 14" x 21.25"	36 lbs.	6U
FZER8HW	21.5" x 17.5" x 21.25"	39 lbs.	8U

### Flight Ready Series

MODEL	DIMENSIONS	WEIGHT	SPACES
FRER2	22" x 5.5" x 20"	15 lbs.	2U
FRER4	21.375" x 9.25" x 20.125"	19 lbs.	4U
FRER6	22.5" x 14.25" x 22"	20 lbs.	6U
FRER8	21" x 12.5" x 20"	22 lbs.	8U

## TRIPLE COMBO RACKS



FZ494

 Steel hinged rear  
 access door

FZ496

Our Triple Combo Rack features 4 spaces on top, a 9 space slanted section, and 4 or 6 spaces below. A rear panel swings open to provide access to gear connections and cabling. Top section rack depth is 5".

### Flight Zone Series

MODEL	DIMENSIONS	WEIGHT	SPACES
FZ494	21.5" x 23.5" x 28.5"	45 lbs.	4U(top slant), 9U(bottom slant), 4U(vert.)
FZ496	21.5" x 27.5" x 28.5"	50 lbs.	4U(top slant), 9U(bottom slant), 6U(vert.)

## MICROPHONE CASES

FZMIC12



The FZMIC12 features a foam interior, recessed butterfly latch w/padlock loop, recessed handle, and sturdy ball corners. Holds 12 microphones and has a lockable interior cable compartment.

**FZMIC18**

The FZMIC18 features a foam interior, recessed butterfly latch w/padlock loop, recessed handle, and sturdy ball corners. Holds 18 microphones and has a lockable interior cable compartment.

### Flight Zone Series

MODEL	DIMENSIONS	WEIGHT	FITS
FZMIC12	16" x 17" x 12"	20 lbs.	12 microphones and cables
FZMIC18	23" x 17" x 12"	26 lbs.	18 microphones and cables

## GUITAR AMP HEAD & SPEAKER CABINET CASES



FZGAMPHEAD1



FZGAMPHEAD2X2W



FZG412LW

Protect all your valuable guitar gear with our ATA Guitar Amp and Speaker Cabinet Cases. Their heavy-duty construction keeps your expensive gear safe, gig after gig. Each case features recessed steel latches and spring-loaded handles. For custom fit guitar amp head and speaker cabinet cases check out our custom case division at [www.BCcases.com](http://www.BCcases.com) and look under Express Ship™ Cases.

MODEL	EXT. DIMENSIONS	INT. DIMS	WEIGHT	FITS
FZG412W	32.25" x 37" x 19"	29.75" x 29" x 16.125"	65 lbs.	412 speaker cabinet case w/casteres
FZG412LW	38" x 42" x 23"	34.5" x 33.5" x 20.25"	70 lbs.	412 speaker cabinet case case w/casteres
ZGAMPHEAD1	32" x 14.5" x 13"	30.25" x 12" x 10"	31 lbs.	fits guitar amp head.
FZGAMPHEAD2X2W	32.75" x 34.5" x 20.25"	30.25" x 12" x 10"	81 lbs.	fits 2 guitar amp heads

## GUITAR COMBO AMP CASES



FZGC212W



FZGC410W

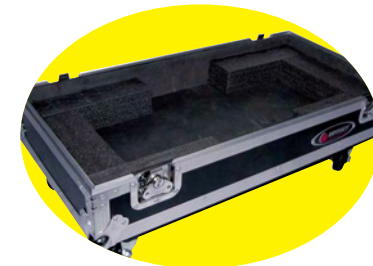

Adjustable Interlocking Foam

Tired of your combo amp getting banged around or busted up? Our new ATA Guitar Combo Amp cases are the perfect solution for safely transporting your 1x12, 2x12, and 410 combo amp. Each case features heavy-duty handles, casters, and latches for the ultimate in protection. The interlocking foam inserts allow you to customize the fit for most amps. Check the specs below to see if your amp will fit. For custom fit guitar amp cases check out our custom case division at [www.BCcases.com](http://www.BCcases.com) and look under Express Ship™ Cases.

\*Custom made cases are available for your specialty amp.

MODEL	EXT. DIMENSIONS	INT. DIMS	WEIGHT	FITS
FZGC112W	29" x 32" x 16.5"	27" x 22" x 14.3"	58 lbs.	1 x 12 Guitar Amps
FZGC212W	34" x 31" x 17.75"	31.75" x 24" x 15.5"	65 lbs.	2 x 12 Guitar Amps
FZGC410W	26.5" x 32" x 14.75"	24" x 24" x 12"	52 lbs.	410 combo head

## GUITAR PEDAL BOARD CASES

**FZGPEDAL24**

**FZGPEDAL32W**  
*(w/recessed rollers)*

**FZGPEDAL17**

### Flight Zone Series

MODEL	DIMENSIONS	WEIGHT	FITS
FZGPEDAL17	19.25" x 9.5" x 19.5"	20 lbs.	pedals up to 17" wide on a removable plate
FZGPEDAL24	25.5" x 9.5" x 19.5"	25 lbs.	pedals up to 24" wide on a removable plate
FZGPEDAL32W	39.75" x 9.5" x 19.5"	30 lbs.	pedals up to 32" wide on a removable plate (features rollers)

## KEYBOARD CASES

**FZKB37**

**FZKB49W**

Our heavy-duty ATA Keyboard Cases can handle the harsh realities of life on tour as well as constant short haul transport. Comes equipped with recessed rollers for easier transport of heavier keyboards. For custom fit keyboard cases check out our custom case division at [www.BCcases.com](http://www.BCcases.com) and look under Express Ship™ Cases.

**FZKB61W**

### Flight Zone Series

MODEL	EXT. DIMENSIONS	WEIGHT	INT. DIMENSIONS	FITS
FZKB31	29.2" x 8.2" x 18.9"	18 lbs.	26" x 4.5" x 14.5"	most 31-note keyboards
FZKB37	38" x 9" x 18"	32 lbs.	36" x 6.5" x 15"	most 37-note keyboards
FZKB49W	41.75" x 9.25" x 18.5"	38 lbs.	38.5" x 6.25" x 15.25"	most 49-note keyboards
FZKB61W	49" x 10" x 20"	43 lbs.	43.3" x 7" x 16.5"	most 61-note keyboards
FZKB76W	56" x 10" x 20"	52 lbs.	51.3" x 7" x 17"	most 76-note keyboards
FZKB88W	63" x 10" x 24"	63 lbs.	58.3" x 7" x 21"	most 88-note keyboards

Also available:

## KEYBOARD COVERS



*Fold it up and go!*



*Cover storage bag*

MODEL	FITS
ASCK25	stretch cover for most 25-note keyboards
ASCK31	stretch cover for most 31-note keyboards
ASCK37	stretch cover for most 37-note keyboards
ASCK49	stretch cover for most 49-note keyboards
ASCK61	stretch cover for most 61-note keyboards
ASCK76	stretch cover for most 76-note keyboards
ASCK88	stretch cover for most 88-note keyboards

# LIVE SOUND MIXER CONSOLE CASES

**FZCFX16**

**FZ5014**

**FZONYX1620**

**FZ240024W**

Comes with recessed rollers

**FZMX9000CW**

Comes with 4 caster wheels

Our heavy-duty ATA Live Sound Mixer Console Cases can handle the harsh realities of life on tour as well as constant short haul transport. If you don't see your mixer listed, call us and we'll build you a case for it. For custom fit live sound mixer console cases check out our custom case division at [www.BCases.com](http://www.BCases.com) and look under Express Ship™ Cases.

### Flight Zone Series

MODEL	EXT. DIMENSIONS	INT. DIMS	WEIGHT	FITS
<b>ALLEN &amp; HEATH</b>				
FZ240024W	38.75" x 9.25" x 28"	36" x 7" x 22.5"	51 lbs.	Allen & Heath 240024 Mixer (w/ recessed rollers)
FZGL2200432W	48.5" x 9.5" x 28.25"	46" x 6" x 22.625"	53 lbs.	Allen & Heath GL2200-4BUS 32CH
<b>BEHRINGER</b>				
FZ3282	42.5" x 8.5" x 26.5"	40" x 6.5" x 21"	46 lbs.	Behringer 3282A mixer
FZMX9000CW	40.5" x 12.25" x 41.25"	38" x 10" x 39"	91 lbs.	Behringer MX9000 mixer (case includes 4 casters)
FZPMH5000	26.25" x 8.75" x 25.75"	23.7" x 6.75" x 22.75"	30 lbs.	Behringer PMH5000 powered mixer/Samson TXM20
FZSL2442	29.5" x 9" x 22"	27.1" x 6" x 19.5"	33 lbs.	Behringer Eurodesk SL2442FX-PRO mixer
<b>MACKIE</b>				
FZCFX12	20.05" x 7.25" x 18"	18.625" x 5" x 12.875"	14 lbs.	Mackie CFX12MKII mixer
FZCFX16	25" x 7" x 18.5"	23.2" x 5" x 16.25"	17 lbs.	Mackie CFX16MKII mixer
FZCFX20	29.25" x 8" x 18.5"	25.625" x 8.5" x 19"	20 lbs.	Mackie CFX20MKII mixer
FZM244	34" x 9.5" x 25"	22.125" x 6" x 31.125"	36 lbs.	Mackie SR24.24 mixer
FZONYX1620	20" x 9.75" x 26.75"	17.6" x 6" x 25.3"	27 lbs.	Mackie ONYX 1620 mixer
FZONYX1640	21" x 10.5" x 30"	18" x 7.8" x 27"	31 lbs.	Mackie ONYX 1640 mixer
<b>PEAVEY</b>				
FZ24FX24	27.25" x 11" x 24"	24.5" x 9.5" x 22"	34 lbs.	Peavey 24FX channel mixer
FZ32FX32W	35.25" x 10.5" x 24.5"	33" x 7.5" x 22"	42 lbs.	Peavey 32FX channel mixer (w/recessed rollers)
FZPV14	18.25" x 5.5" x 17.5"	16.3" x 3.5" x 17.5"	12 lbs.	Peavey PV14 mixer
<b>YAMAHA</b>				
FZ02R96W	30.5" x 17" x 35.5"	27.75" x 14.3" x 33.1"	59 lbs.	Yamaha 02R96V2 digital mixer (w/recessed rollers)
FZ5014	20" x 9.25" x 24.5"	17.5" x 6.5" x 22"	26 lbs.	Yamaha EMX5014C/EMX5016CF mixing console
FZEMX500012	21.5" x 8.75" x 26.25"	19" x 5.3" x 24.8"	29 lbs.	Yamaha EMX5000 12 channel mixer
FZEMX500020	28" x 8.75" x 26"	23.8" x 6.5" x 27"	34 lbs.	Yamaha EMX5000 20 channel mixer
FZMG16E	21.5" x 6.75" x 18.25"	18.25" x 4.5" x 16.7"	13 lbs.	Yamaha MG16E/MG16FX
FZMG2414W	34.75" x 8.5" x 27.25"	32.5" x 6" x 24"	43 lbs.	Yamaha MG24/14 FX 14 bus mixer (w/recessed rollers)
FZMG32W	43.5" x 9" x 28"	40.75" x 8" x 25"	49 lbs.	Yamaha MG32/14 FX 14 bus mixer (w/recessed rollers)
<b>UNIVERSAL CASES</b>				
FZ19MIX	21.5" x 10.5" x 20"	19" x 6.5" x 17.5"	24 lbs.	Universal 19" rackmount mixer up to 10U
FZMX1912	21.5" x 10" x 26.5"	17.5" x 7" x 21"	34 lbs.	Universal 19" rackmount mixer up to 12U
FZNR19MIX	21.75" x 10.75" x 23.75"	19.25" x 7.5" x 21"	28 lbs.	Universal 19" non-rack mount mixer (up to 21" wide)

## UTILITY CASES • LIGHTING/PAR CANS

**FZPAR2W**
**FZPAR1**

**FZSLDC2W**
**FZSLDC1**

Recessed rollers for easy transportation on the FZSLDC2W

Keep your gear looking like new in these versatile utility cases. Carpet lined interior walls make these the perfect storage cases for sound, lighting gear, etc. No more storing your gear in old cardboard boxes.

### Flight Zone Series

MODEL	DIMENSIONS	WEIGHT	FITS
FZPAR1	48" x 20" x 16.5"	50 lbs.	(4) Par 56s with tripod stand and accessories
FZPAR2W	56" x 24.75" x 22.5"	110 lbs.	(8) Par 64s with tripod stand and accessories (features casters)
FZSLDC1	22" x 10" x 22"	20 lbs.	Assorted lighting fixtures or other lightweight gear
FZSLDC2W	31" x 20" x 14"	33 lbs.	Assorted lighting fixtures or other lightweight gear (features rollers)

## MOVING HEAD CASES

Get your moving head lights to where the action is well protected in our sturdy moving head cases. They feature heavy-duty casters, recessed spring-loaded latches, and ball corners. The FZMH250X2W fits moving heads by Chauvet, Coemar, Elation, Martin, and Robe.

**FZMH250SX2W**

Holds small-sized moving heads such as:

- American DJ Accuspot 250
- American DJ Accuspot 300
- American DJ Autospot 150
- Pearl River Pilot 150
- Chauvet Legend 150
- Chauvet Mini Legend 150
- Also fits LED equipped moving heads

### Flight Zone Series

MODEL	DIMENSIONS	WEIGHT	FITS
FZMH250SX2W	34.25" x 33" x 17.75"	85 lbs.	hold (2) 250 style small moving heads
FZMH2502W	21" x 35.5" x 36"	100 lbs.	hold (2) 250 style large moving heads

## PLASMA/LCD/LED SCREEN CASES

**FZ2PLASMA42W**

Our Dual plasma cases can accommodate one or two Plasmas/LCD/LED's. Keep yours safe in transit with our single or dual 42" and 50" ATA cases. Foam-end pieces adjust for width while incremental etha foam strips allow for various screen thicknesses.

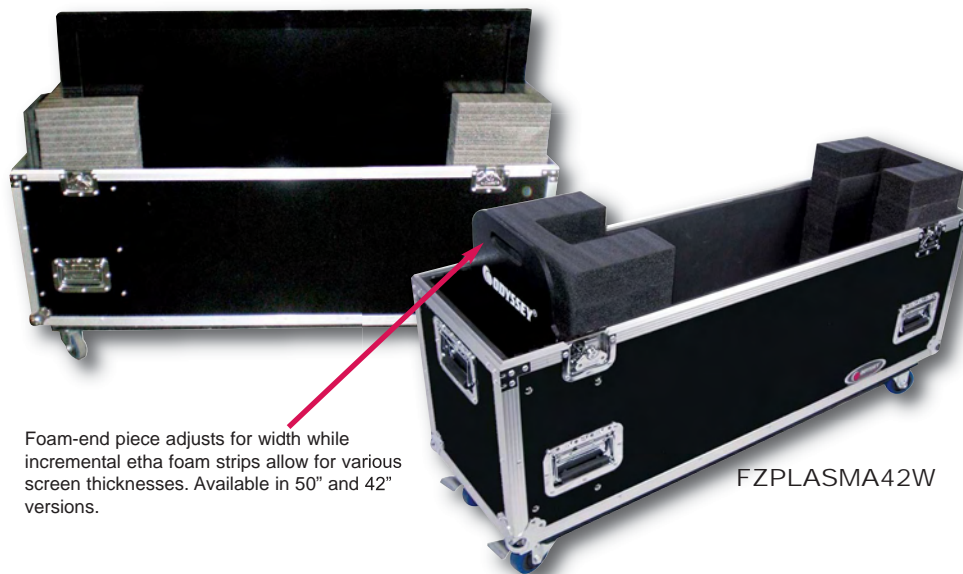
**FZPLASMA42W**

Foam-end piece adjusts for width while incremental etha foam strips allow for various screen thicknesses. Available in 50" and 42" versions.

### Flight Zone Series

MODEL	DIMENSIONS	WEIGHT	FITS
FZ2PLASMA42W	53" x 41" x 22"	146 lbs.	fits 2 displays between 36.5" - 43" wide
FZ2PLASMA50W	59.75" x 44.5" x 22"	112 lbs.	fits 2 displays between 47" - 55" wide
FZPLASMA42W	49.5" x 37" x 15.25"	102 lbs.	fits display between 36.5" - 43" wide
FZPLASMA50W	62.5" x 44.5" x 16.5"	112 lbs.	fits display between 47" - 55" wide

## StakPak™ SERIES UTILITY CASES

**FZUT34422**

Keep all your essential cables and gear safe during transport and organized to boot with our utility StakPak™ cases. All cases feature removable divider, foam lined interior, piano-hinged lid, recessed latches and handles, and heavy-duty ball corners.

**FZUT32222**

**FZUT34417**

**FZUT32722**

**FZUT34422W**

### Flight Zone Series

MODEL	DIMENSIONS	INT. DIMENSIONS	WEIGHT
FZUT32222	22" x 22" x 22"	19.5" x 17" x 19.5"	44 lbs.
FZUT32722	27" x 18" x 22"	24.5" x 13" x 19.5"	44 lbs.
FZUT34417	44" x 19" x 17"	41.5" x 13" x 14.5"	52 lbs.
FZUT34422	44" x 23" x 22"	41.5" x 17" x 19.5"	71 lbs.
FZUT34422W	44" x 27" x 22"	41.5" x 17" x 19.5"	91 lbs.

## UTILITY CASES • TRUCK PACKS



### Flight Zone Series

**MODEL** FZTP090W  
**DESCRIPTION** 3 piece Truck Packs can hold a wide variety of gear. Bottom box has caster wheels.

**Ext. Dims:** (2) Top 21" x 18" x 16"  
 (1) Bottom 32" x 22.5" x 21"

Truck Packs are able to store and transport all that extra gear you need. Comes standard with recessed hardware and carpet lined interior.

## UTILITY CASES • TRUCK PACKS

These big boys can hold a ton of gear and keep it all organized to boot! Both cases feature 3.5" heavy-duty caster, 2 with breaks, and can hold gear up to 42" x 27" and up to 23" deep (26" from floor to top lid). The FZUT2W comes well-equipped with 7 dividers (2 tall, and 5 flush). One small and one large tray sit on top of the flush dividers. Use any combination of trays and dividers to keep all your gear safe during transport. The FZUT2W-EMPTY version comes without trays and dividers.



FZUT2W



Removable dividers

Made to truck pack dims!



FZTP020W

Fast and efficient use of space for easy loading in and out of venues. The base has 3 inch casters, two of which have brakes. Feature recessed hardware and spring-loaded handles.



FZUT2W-EMPTY

### Flight Zone Series

MODEL	DIMENSIONS	INT. DIMENSIONS	WEIGHT
FZTP020W	22" x 29.34" x 22"	20" x 20" x 20"	46 lbs.
FZTP02230W	25" x 36" x 25"	23" x 26.5" x 23"	54 lbs.

### Flight Zone Series

MODEL	DIMENSIONS	INT. DIMENSIONS	WEIGHT
FZUT2W	44.75" x 31" x 29.5"	42" x 23" x 27"	166 lbs.
FZUT2W-EMPTY	44.75" x 31" x 29.5"	42" x 23" x 27"	120 lbs.

## UTILITY CARRYING CASES

**FZWIRELESS**

Protect your valuable digital recorders, samplers, drum machines, controllers and other tabletop gear with our Utility Carrying Cases. These cases come with pre-cut, diced foam so it's easy to make the foam interior match the shape of just about anything you put inside! The FZUC (small Utility Case) and FZWIRELESS (Wireless System Case) cases come with a lockable luggage type clasp and non-removable hinged lid that stays open and upright by itself. The larger FZLUC (Large Utility Case) and FZDRC (Digital Recorder Case) feature heavy-duty butterfly latches with padlock slots and removable hinged lids.

### Flight Zone Series

MODEL	DIMENSIONS	WEIGHT
FZUC	15" x 6.5" x 13"	5 lbs.
FZDRC	24.75" x 10" x 20.375"	19 lbs.
FZLUC	23.5" x 6.75" x 11.75"	9 lbs.
FZWIRELESS	19" x 4.75" x 18"	11 lbs.

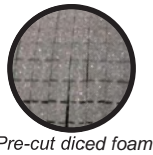
*Pre-cut diced foam*

**FZUC**

**FZLUC**

**FZDRC**

### D.I.Y. DICED FOAM:

*Trace your gear on a sheet of paper*

*Cut out the pattern. Cut inside the lines for a tighter fit.*

*Put pattern in desired position and pull foam apart*

*Test fit and pull more foam as needed*

## UTILITY INJECTION MOLDED CASES WATERTIGHT & DUSTPROOF



Our polymer plastic water-tight, dust-proof and impact resistant injection molded cases are made of a high strength polymer resin which will provide the ultimate in protection for your gear. Each case features a diced foam interior that can be plucked to the shape of the gear you are storing inside. Standard features include a comfortable carrying handle, pressure release valve and padlock loops.



Watertight seal



Pressure release valve

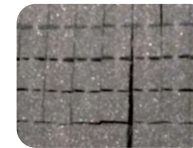

Easy to shape pluck foam included

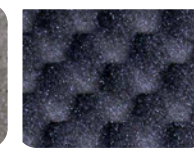

Soft, egg crate foam lid lining

**VU170714HW**
*\*Base Height*

MODEL	DIMENSIONS	INT. DIMENSIONS	*BASE HEIGHT	WEIGHT
VUXS	8.5" x 3.5" x 7.25"	7" x 2.75" x 4.625"	2.5"	2 lbs.
VUS	13" x 5" x 11.125"	11.5" x 4" x 8.25"	3"	5 lbs.
VUM	17" x 6.25" x 15.125"	15.25" x 5.25" x 12"	4.5"	8 lbs.
VUL	20.5" x 7.825" x 16.5"	18.25" x 7" x 13.5"	4"	9 lbs.
VU170714HW	18.5" x 9" x 15.5"	17" x 7" x 14"	5"	11 lbs.
VU200711HW	22" x 9" x 14"	20" x 7" x 11.5"	5"	11 lbs.

## CARPET GLIDE STYLE CD/DIGITAL DJ COFFINS LARGE FORMAT



CGS10CDJ

Large format CD/Digital DJ Coffins fit players such as:  
 American Audio Flex 100 MP3/  
 Radius1000/3000  
 Denon DN-S3700  
 Gemini CDJ210/600  
 Numark NDX800  
 Pioneer CDJ-1000MK3  
 800MK2/850  
 Stanton C-324



MODEL	DIMENSIONS	WEIGHT	FITS
CGS10CDJ	44.5" x 9.5" x 22"	38 lbs.	10" mixer, (2) large format CD/Digital Media Players
CGS12CDJ	48" x 9.5" x 20.25"	40 lbs.	12" mixer, (2) large format CD/Digital Media Players

\*This case is not designed to transport laptops.

## CARPET GLIDE STYLE TURNTABLE DJ COFFINS



CGSBM10

Holds Numark, Stanton, as well as Technics 1200 style turntables!



MODEL	DIMENSIONS	WEIGHT	FITS
CGSBM10	47.5" x 9.25" x 21.25"	52 lbs.	10" mixer, (2) 1200 style turntables in battle mode
CGSBM12	52" x 9.25" x 21.5"	54 lbs.	12" mixer, (2) 1200 style turntables in battle mode

\*This case is not designed to transport laptops.

## TURNTABLE CASES/DJ COFFINS 1200 CASES

 CTTP PRO  
 Pro Version

Our pro carpeted single turntable case is made of a long lasting durable carpet finish and comes standard with steel recessed hardware including stackable ball corners. Standard model also available with surface mount hardware.

MODEL	DIMENSIONS	WEIGHT	FITS
CTTE (Standard)	22.5" x 8.5" x 17"	20 lbs.	1200 style turntable
CTTP (Pro)	22.5" x 8.5" x 17"	18 lbs.	1200 style turntable

## TURNTABLE DJ COFFINS

 CDJ10  
 Pro Version

A 10" style mixer is the standard for those DJs who prefer to mix in the standard turntable position. Standard model with surface mount hardware also available.

 CDJ19P  
 Pro Version

Our 19" mixer carpet-covered DJ coffins are made to last regardless of which model you choose. Our standard "E" model has surface mount hardware. The "P" version has all the bells and whistles, with fully foam-lined turntable wells and recessed hardware.

MODEL	DIMENSIONS	WEIGHT	FITS
CDJ10E (Standard)	52" x 7" x 18.5"	42 lbs.	10" style mixer, (2) 1200 style turntables (actual mixer well is only 9.25" in width)
CDJ10 (Pro)	52" x 7" x 18.5"	47 lbs.	10" style mixer, (2) 1200 style turntables (actual mixer well is only 9.25" in width)
CDJ19E (Standard)	57" x 8" x 16"	48 lbs.	19" mixer, (2) 1200 style turntables
CDJ19P (Pro)	63" x 8.5" x 18"	50 lbs.	19" mixer, (2) 1200 style turntables

## TURNTABLE DJ COFFINS • BATTLE MODE

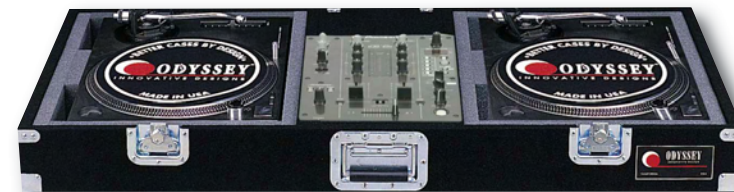
 CBM10  
 Pro Version

Our carpeted Battle Mix Coffin for 10" mixers features turntables in the preferred alignment for scratch DJs. Also great for vinyl DJs who want a smaller coffin. Available in Pro and Standard Version.

MODEL	DIMENSIONS	WEIGHT	FITS
CBM10E (Standard)	57" x 7.5" x 21.5"	42 lbs.	10" style mixer, (2) 1200 style turntables (actual mixer well is only 9.25" in width)
CBM10 (Pro)	57" x 7.5" x 21.5"	47 lbs.	10" style mixer, (2) 1200 style turntables (actual mixer well is only 9.25" in width)

## BRAND SPECIFIC DJ COFFINS



CPI5TDJ



CPI61000

MODEL	DIMENSIONS	WEIGHT	FITS
CPI61000	48" x 8.5" x 20"	42 lbs.	Pioneer DJM-500/600/700/800 mixer and (2) CDJ1000 players
CPI6800	46" x 8.5" x 20"	45 lbs.	Pioneer DJM-500/600/700/800 mixer and (2) CDJ-800 CD players
CPI5TDJ	57" x 7.5" x 21.5"	55 lbs.	Pioneer DJM-500/600/700/800 mixer and (2) 1200 style turntables

## TURNTABLE COMBO DJ COFFINS



CDJ19R06W

Our turntable combo coffins are capable of housing your 19" mixer with 2 turntables in standard position and dual 3 space racks below the main set up. Heavy-duty carpet covering and 3" casters make this the perfect combo case for the serious working DJ.

- 59" x 15" x 18", 88 lbs.
- Foam Padding: top, bottom
- Hardware: recessed, 2 corner wheels
- Vertical Rack: 3U x 2

## TWIN RACKS

**CS132T**  
 SLIDE STYLE™

CT18

Available in so many different configurations, you're bound to find the right model to suit your style of mixing. If you don't see what you're looking for, chances are we have already make it, we just didn't have enough room in this catalog to show them all.

MODEL	DIMENSIONS	WEIGHT	HOLDS
CS132T06	41" x 23.5" x 18"	74 lbs.	8U slant, above 8U, 5U, and (2) Turtables
CS132T	41" x 16.5" x 17"	55 lbs.	8U slant, above 5U, L:3U R: 3U
CS232T	61" x 14.25" x 17.5"	73 lbs.	T: 8U B:7U slant, above L:4U R:4U
CT18	41" x 12" x 24.5"	60 lbs.	L: 10U slant+2U, R: 6U
CT22	41" x 16" x 24.5"	64 lbs.	L: 10U slant+4U, R: 8U

## GEMINI CD/DIGITAL MEDIA MIXER CASE



Rear View

### CGCDM500

- WxHxD: 22.5" x 9" x 14.5"
- Weight: 18 lbs.

The Gemini CDM-3200/CDM-3600/CDMP6000 players fit perfectly in our CGCDM500 carpeted case designed specifically for these units. There's additional space behind the unit for cables, a flip-down door for easy access. The interior is fully foam-lined, and there's a rear porthole for your power cable. Includes detachable lid (not shown).

## CD/DIGITAL MEDIA MIXER RACKS



**CNMCM1CD**  
Carpeted case holds (1)  
Numark CD Mix 1, 2, & 3 /  
iCDMIX 2 & 3 / KMX02  
plus 2 rows of CD's

**CNMCM1**  
Carpeted case holds (1)  
Numark CD Mix 1, 2, & 3 /  
iCDMIX 2 & 3 / KMX02



**CNMCM106**  
Carpeted case holds (1) Numark CD  
Mix 1, 2, & 3 / iCDMIX 2 & 3 /  
KMX02 and 6 vertical rack spaces.



MODEL	DIMENSIONS	WEIGHT	FITS
CNMCM1	21" x 9" x 15.5"	22 lbs.	CD Mix 1, 2 & 3 / iCDMIX 2 & 3 / KMX02
CNMCM1CD	32" x 9" x 15.5"	29 lbs.	CD Mix 1, 2 & 3 / iCDMIX 2 & 3 / KMX02
CNMCM106	21" x 30.5" x 22"	45 lbs.	CD Mix 1, 2 & 3 / iCDMIX 2 & 3 / KMX02

## CD/DVD/VIDEO GAME DISC CASES



**CCD300E**  
Standard Version



**CCD450E**  
Standard Version



**CCD320PW**  
PRO Version

### Pro Series

MODEL	DIMENSIONS	WEIGHT	FITS
CCD300P	24.5" x 7" x 13"	18 lbs.	300 view packs 100 Jewel Cases
CCD450P	24.5" x 7" x 14"	22 lbs.	450 view packs 150 Jewel Cases
CCD320PW	46" x 8" x 18.5"	40 lbs.	320 view packs 105 Jewel Cases

### Standard Series

MODEL	DIMENSIONS	WEIGHT	FITS
CCD225E	19" x 7" x 12.5"	13 lbs.	225 view packs 75 Jewel Cases
CCD300E	24.5" x 7" x 13"	15 lbs.	300 view packs 100 Jewel Cases
CCD450E	24.5" x 7" x 14"	20 lbs.	450 view packs 150 Jewel Cases

## LP/UTILITY CASES

 CLP180E  
 Standard Version

 CLP200P  
 Pro Version

 CLP100P  
 Pro Version

 CLP260PW  
 Pro Version

*Heavy-duty latches, extra compartments and durable carpet covering add to the protection of 260 of your best friends.*

### Pro Series

MODEL	DIMENSIONS	WEIGHT	FITS
C45200	25.5" x 8" x 12"	18 lbs.	200 45 rpm records.
CLP100P	15" x 15" x 9"	18 lbs.	100 LPs
CLP200P	28" x 15" x 14.5"	35 lbs.	200 LPs
CLP260PW	35.5" x 15" x 18"	50 lbs.	260 LPs (includes extra storage compartment)

### Standard Series

MODEL	DIMENSIONS	WEIGHT	FITS
CLP090E	15" x 15" x 14"	16 lbs.	90 LPS
CLP180E	28" x 15" x 14"	32 lbs.	180 LPs

## STANDARD SERIES AMP RACKS



CRE10



CRE08



CRE12W

Our CRE series racks are super durable, featuring all plywood construction, metal hardware, heavy-duty pretapped rack rails, recessed large grip handles, friction fit front and rear lids and large rubber feet or 3" caster wheels.

MODEL	SPACE	DIMENSIONS	INT. DEPTH	WEIGHT	HANDLES	3" CASTERS
CRE02	2U	21" x 6" x 20"	17"	23 lbs.	1	no
CRE04	4U	21" x 9.5" x 20"	17"	26 lbs.	1	no
CRE06	6U	21" x 13" x 20"	17"	30 lbs.	2	no
CRE08	8U	21" x 16.5" x 20"	17"	33 lbs.	2	no
CRE10	10U	21" x 20" x 20"	17"	38 lbs.	2	optional
CRE12	12U	21" x 25.5" x 20"	17"	45 lbs.	2	no
CRE12W	12U	21" x 28.5" x 20"	17"	53 lbs.	2	yes
CRE14	14U	21" x 28.5" x 20"	17"	50 lbs.	2	no
CRE14W	14U	21" x 32" x 20"	17"	58 lbs.	2	yes
CRE16	16U	21" x 32" x 20"	17"	55 lbs.	2	no
CRE16W	16U	21" x 35.5" x 20"	17"	63 lbs.	2	yes
CRE18	18U	21" x 35.5" x 20"	17"	60 lbs.	2	no
CRE18W	18U	21" x 39.75" x 20"	17"	68 lbs.	2	yes

*"W" version includes wheels for easy transportation*

## PRO SERIES AMP RACKS



CRP16W



CRP08W



CRP04



Patented Edgeguard™ PROTECTED

Our CRP series racks feature all plywood construction, metal hardware, heavy-duty pre-tapped rack rails, recessed large grip handles, recessed flush mount lids with latches, and large heavy-duty steel corners. The "W" models include 3" super strong caster wheels and pre-installed T-nut fasteners.

MODEL	SPACE	DIMENSIONS	INT. DEPTH	WEIGHT	HANDLES	3" CASTERS
CRP02	2U	21" x 7.5" x 22"	18.5"	29 lbs.	2	no
CRP04	4U	21" x 10.5" x 22"	18.5"	33 lbs.	2	no
CRP06	6U	21" x 14" x 22"	18.5"	38 lbs.	2	no
CRP08	8U	21" x 17.5" x 22"	18.5"	42 lbs.	2	no
CRP08W	8U	21" x 21.5" x 22"	18.5"	46 lbs.	2	yes
CRP10	10U	21" x 21" x 22"	18.5"	47 lbs.	2	no
CRP10W	10U	21" x 25" x 22"	18.5"	55 lbs.	2	yes
CRP12	12U	21" x 25.5" x 22"	18.5"	52 lbs.	4	no
CRP12W	12U	21" x 29.5" x 22"	18.5"	60 lbs.	4	yes
CRP14W	14U	21" x 32.5" x 22"	18.5"	65 lbs.	4	yes
CRP16W	16U	21" x 36.5" x 22"	18.5"	70 lbs.	4	yes
CRP18	18U	21" x 36" x 22"	18.5"	78 lbs.	4	no
CRP18W	18U	21" x 40" x 22"	18.5"	86 lbs.	4	yes

"W" version includes wheels for easy transportation

## PRO SERIES COMBO RACKS

Available in 5 sizes, these cases feature an angled, protruding top section and flush mount angle on the pro133, pro136 and is . Pro series cases feature removable top and front covers, removable rear access panel for easy cable hook ups.



PRO106

PRO103

MODEL	DIMENSIONS	WEIGHT	SLANTED	VERTICAL
PRO103	21.5" x 17.25" x 20"	42 lbs.	10U	3U
PRO106	21.5" x 22.50" x 20"	52 lbs.	10U	6U
PRO108	21.5" x 26" x 20"	55 lbs.	10U	8U
PRO133	21.5" x 23" x 24"	50 lbs.	13U	3U
PRO136	21.5" x 27" x 24"	60 lbs.	13U	6U

## CXC SERIES COMBO RACKS

The CXC Combo series features a flush mount slanted top section. Unique to Odyssey cases, the removable front & back access panels are interchangeable. Just one less thing to worry about for quick break down of equipment after a gig.



CXC902

CXC1016W

MODEL	DIMENSIONS	WEIGHT	SLANTED	VERTICAL
CXC902	21.5" x 15.5" x 20"	37 lbs.	9U	2U
CXC904	21.5" x 19" x 20"	42 lbs.	9U	4U
CXC908	21.5" x 26" x 20"	50 lbs.	9U	8U
CXC1016W	21.5" x 42" x 20"	78 lbs.	10U	16U

"W" version includes wheels for easy transportation



SURFACE MOUNT LATCHES HEAVY DUTY HANDLES.

## CXP SERIES COMBO RACKS

### FEATURES:

- Angled protruding top
- Slanted top - 11 space standard
- Recessed Steel Latches & Handle
- Pretapped steel rack rails
- Edge Guard™ front and rear
- 3" heavy-duty caster wheels
- 3/4" multi-layer AA grade premium plywood
- Interchangeable front & back panels
- Add rear rack rails for added gear support. (Optional)



CXP1118W  
Edgeguard™ PROTECTED



CXP1112W  
Edgeguard™ PROTECTED

### THE MOST POPULAR COMBO RACK PREFERRED BY AUDIO PROFESSIONALS!

Our combo racks hold a variety of components up to 18 spaces! They come equipped with recessed soft grip spring-loaded handles and heavy-duty 3" caster wheels for comfortable transport from gig to gig. The front and rear patented Edgeguard prevents direct impact to your case. Request the optional cam-locks to your case and secures all your rackable components to deter theft and damage to your valuable equipment.

MODEL	DIMENSIONS	INT DEPTH	WEIGHT	SLANT	VERTICAL	CASTERS
CXP1102	22" x 16.5" x 22"	18.5"	42 lbs.	11U	2U	NO
CXP1104	22" x 20" x 22"	18.5"	47 lbs.	11U	4U	NO
CXP1106	22" x 23" x 22"	18.5"	52 lbs.	11U	6U	optional
CXP1108	22" x 27" x 22"	18.5"	57 lbs.	11U	8U	NO
CXP1108W	22" x 31" x 22"	18.5"	65 lbs.	11U	8U	YES
CXP1110	22" x 30.5" x 22"	18.5"	62 lbs.	11U	10U	NO
CXP1110W	22" x 34.5" x 22"	18.5"	70 lbs.	11U	10U	YES
CXP1112	22" x 34" x 22"	18.5"	67 lbs.	11U	12U	NO
CXP1112W	22" x 38" x 22"	18.5"	75 lbs.	11U	12U	YES
CXP1114W	22" x 41.75" x 22"	18.5"	82 lbs.	11U	14U	YES
CXP1116W	22" x 45.25" x 22"	18.5"	88 lbs.	11U	16U	YES
CXP1118W	22" x 49" x 22"	18.5"	95 lbs.	11U	18U	YES

"W" version includes wheels for easy transportation

## CXG SERIES COMBO RACKS

### COMBO ON THE GO!

#### Essential Dimensions

- Top (Mixer Section) 9 spaces
- Bottom (Rack Section): avail. in 2, 4, 6, or 8 spaces
- Internal Depth: (Rack Section) 17"



CXG902  
Edgeguard™ PROTECTED



CXG908  
Edgeguard™ PROTECTED

MODEL	DIMENSIONS	WEIGHT	VERTICAL
CXG902	21.5" x 12.5" x 20"	32 lbs.	2U
CXG904	21.5" x 16.0" x 20"	35 lbs.	4U
CXG906	21.5" x 19.5" x 20"	40 lbs.	6U
CXG908	21.5" x 23.0" x 20"	44 lbs.	8U

## SLIDE STYLE™ COMBO RACKS

Our patented Slide Style cases are thoughtfully designed and solidly built. Functional yet unobtrusive, they're practical for all DJs needing horizontal access to their gear. Essential in protecting your racked gear, like drive bays, EQs or other control panels above the mixer section. Features solid aluminum rails to slide the top rack back for easier access to controls on your mixer or other gear.



CS4812W  
Edgeguard™ PROTECTED



MODEL	DIMENSIONS	INT DEPTH	WEIGHT	TOP	SLANTED	BOTTOM	HANDLES	EDGEGUARD
CS4800	21" x 15" x 17.5"	18.5"	36 lbs.	4U	8U	N/A	2	No
CS4812W	22" x 45" x 22"	18.5"	97 lbs.	4U	8U	12U	4	Yes
CS4814W	22" x 48.5" x 22"	18.5"	104 lbs.	4U	8U	14U	4	Yes

"W" version includes caster wheels for easy transportation

## LAPTOP SLIDE STYLE™ COMBO RACKS

Our laptop Slide Style™ racks are made to hold a total of 8 spaces at the mixer slant, 2 spaces that slide back up above and your laptop right above it all. This patented design makes the life of the laptop digital DJ that much more efficient. Made with all recessed hardware and spring-loaded handles.



CSL28  
Slide Style™

CSL2802  
Slide Style™



CSL2802

Setting up for gigs is even easier with our CSL2802. Just connect your laptop and you are ready to go!

MODEL	DIMENSIONS	WEIGHT	SPACE
CSL28	22" x 18" x 22"	48 lbs.	2U+8U
CSL2802	22" x 21" x 22"	51 lbs.	2U+8U+2U

## STUDIO RACKS



CRS14W



CRS20W



CRS08



2" or 3" Castor  
Wheels on "W"  
models

Our carpeted studio racks keep your studio tidy and looking good at the same time. They feature 3/4" multi layered plywood construction and an angled face for easy viewing of all your gear, top to bottom. Completely open back; no front or rear covers.

MODEL	SPACE	WIDTH	HEIGHT	DEPTH at Top Space	DEPTH at Bottom Space	WEIGHT	CASTERS
CRS08	8U	21"	19"	12"	16"	28 lbs.	no
CRS12	12U	21"	25"	13"	16"	36 lbs.	no
CRS14W	14U	21"	33"	16"	22"	50 lbs.	2"
CRS20W	20U	21"	42.5"	16"	22"	56 lbs.	2"
CRS24W	24U	21"	50"	16"	22"	65 lbs.	3"
CRS30W	30U	21"	60"	16"	22"	72 lbs.	3"

## KROM CD/DVD/VIDEO GAME DISC CASES



**KCD300**

**KCD300**

- foam-lined, 3-row interior holds approx. 300 CDs in viewpacks or 100 CDs in jewel cases
- 18" x 6.5" x 13", 12 lbs.



**KCD200**



lockable latches deter unwanted access

foam lined, 3-row interior



**KCD200**

- holds approx. 200 CDs in viewpacks or 65 CDs in jewel cases.
- 18" x 9" x 11", 9 lbs.



**KCD600W**

- foam-lined, 4-row interior holds approx. 600 CDs in viewpacks or 200 CDs in jewel cases.

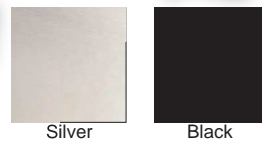

## KROM LP/UTILITY CASES



**KLP1**

The KLP1 holds 70 LPs in its foam lined interior compartment, comes in black or silver, and features a removable lid with a lockable butterfly latch.

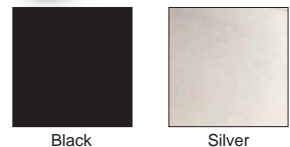

**KLP1**

- holds approx. 70 LPs
- 14" x 14" x 11", 10 lbs.
- 20/80 Split Lid

# REDLINE™ SERIES DIGITAL GEAR BAGS

Odyssey presents the Redline Series, cutting edge bags for today's on the go DJ / Remixer / Producer. The Redline Series™ combines real-world fit and function with creative applications, addressing the demands and needs of the dynamic mobile artist. You quite literally can take all your essential components used for your digital setups in these bags designed for the way you move and the way you play. They're fully padded in all the right places for the ultimate in digital gear protection.

**NEW**  
*AIRFURNIVAL*

## BRLDIGITAL

Features and specs:

- Reinforced Steel Frame Prevents Vertical Crushing and Sagging
- Fully Padded for Gear Protection
- Adjustable Foam Inserts To Customize Main Compartment to Your Gear
- Dedicated Adjustable Compartment for Laptop
- Heavy-Duty Zippers and Zipper Pulls
- Convenient Elastic Band Cable Holders
- Pull-up Handle Sling
- Easy Access Front and Rear Pockets
- Sturdy Bottom Feet Increases Vertical Stability
- Padded Handle and Shoulder Strap for Extra Comfort

Fits gear such as:

- Up to 17" Big Laptop
- Cables
- Hard Drives
- Serato Scratch, Traktor Scratch, and M-Audio Torq Interfaces
- Vinyl, CDs, & Memory Sticks
- and much more!

Dimensions (exterior):

19"W x 15.5"H x 8"D

Weight: 6 lbs.

## BRLTECH

Features and specs:

- Fully Padded for Gear Protection
- Reinforced Protective Frame Prevents Sagging
- Dedicated Adjustable Compartment for Laptop
- Dedicated LSTANDM Laptop Stand Compartment
- Heavy-Duty Zippers and Zipper Pulls
- Includes Clear Mesh Interior Pockets
- Pull-up Handle Sling
- Adjustable Exterior Folding Flap
- Easy Access Front and Rear Pockets
- Sturdy Bottom Feet Increases Vertical Stability
- Padded Handle and Shoulder Strap for Extra Comfort

Fits gear such as:

- Up to 17" Big Laptop
- Cables
- Turntable Needle Cartridge Case
- Hard Drives
- iPad
- Serato Scratch, Traktor Scratch, and M-Audio Torq Interfaces
- Laptop Stand (LSTANDM)
- Vinyl, CDs, & Memory Sticks
- and much more!

Dimensions (exterior):

19"W x 15.5"H x 8"D

Weight 6 lbs.



## BRLBACKSPIN

Features and specs:

- Fully Padded for Gear Protection
- Sturdy Frame Construction Prevents Sagging
- Dedicated Adjustable Compartment for Laptop
- Dedicated Headphone Compartment
- Dedicated LSTANDM Laptop Stand Compartment
- Heavy-Duty Zippers and Zipper Pulls
- Convenient Elastic Band Cable Holders
- Easy Accessible Side and Front Pockets
- Sturdy Bottom Feet Increases Vertical Stability
- Padded Back, Handle, and Shoulder Straps for Extra Comfort

Fits gear such as:

- Up to 17" Big Laptops
- Laptop Stand (LSTANDM)
- Cables
- Turntable Needle Cartridge Case
- Hard Drives
- Headphones
- Serato Scratch, Traktor Scratch, and M-Audio Torq Interfaces
- Vinyl, CDs, & Memory Sticks
- DJ Midi Controllers such as the American Audio VMS4 or smaller
- and much more!

Dimensions (exterior):

17"W x 19"H x 8"D

Weight 6 lbs.

**NEW**  
*AIRFURNIVAL*

## BRL17W

Features and specs:

- High Quality Red Interior and Black Exterior Design
- Fully Padded for Gear Protection
- Reinforced Protective Steel Frame
- Fully Adjustable Padded Dividers
- Padded Laptop Sleeve Included
- Heavy-Duty Zippers and Zipper Pulls
- Includes Clear Mesh Interior Lid Pocket
- Wheels and Patented Telescoping Handle
- Easy Access Side Pockets
- Padded Handle and Shoulder Strap
- Main Compartment is 17"W x 12.25"H x 12"D
- Side pocket Dimensions: 8"W x 12"H
- Top Compartment dimensions: 17"W x 12"H
- Front Compartment dimensions: 15"W x 10.5"H
- 3" Diameter Angled Wheels

Fits gear such as:

- Akai APC40
- Up to 17" Big Laptop
- DJ Mixers
- Tabletop CD/Media Players
- Digital Controllers
- iPad
- Cables
- Turntable Needle Cartridge Case
- Hard Drives
- Serato Scratch, Traktor Scratch, and M-Audio Torq Interfaces
- Laptop Stand (LSTANDM)
- Vinyl, CDs, & Memory Sticks
- and much more!



Dimensions (exterior):

21" x 18" x 40.5" x 16"

Weight 13 lbs.

**REDLINE™**  
 ELITE SERIES

## BCURBAN17 DIGITAL GEAR BAG

BCURBAN17 laptop bag is specifically designed for digital DJs in the laptop arena. It can comfortably hold up to a 17" laptop, LPs, interfaces (i.e. Serato, Torq, etc.) headphones, mics, needle cases, record cleaner and other digital essentials. Flap features zippered pockets, plenty of pockets for all your gear. Outside pockets are great for phones, PDAs, or quick access items. Get to your next gig in style - all in one bag! Simply a better product by design.



**BCURBAN17**  
• Ext. Dims: 18.25"W x 15"  
• Weight: 2.8 lbs.

## HEADPHONES/HEADPHONE POUCH



*Also fits the Serato Scratch Live as well as other laptop interfaces and pocket hard drives!*

Keep your headphones looking new with our Headphone Pouch. Also great for holding any type of small gear you don't want to lose or get scratched up.

**BHP**  
• Dims: 7.5" x 0.25" x 9.5"

## RACK BAGS

Our Rack Bags are made of an 800 Denier ballistic nylon covering that withstands the challenges of constant transport. Stylish zipper pulls are chrome plated and can be locked together for added security. A roomy outside zippered pocket allows for storage of all the essentials such as mics, cables, etc. Absolutely the best rack bag ever designed and built for the music industry professional.



BR308



BR412

### FEATURES:

- complete access to front & back of racked gear
- comfortable shoulder strap
- front pocket storage compartment



*Our unique rack bags allow you to remove the interior hard shell from the padded bag so you can stack racks firmly on top of each other without the bag getting in the way! All rack bags include a shoulder strap along with a small bag of rack screws and washers.*



*The black carpet covered interior shell is studio furniture friendly - no rubber feet or metal edges to damage or mark surfaces.*



*Complete access with front and rear opening. Odyssey rack bags allow for both front and rear access without removing the interior shell.*

### AVAILABLE IN:

MODEL	SPACE	DIMENSIONS	RACKABLE DEPTH	WEIGHT
BR308	3U	22" x 7" x 10"	8"	10 lbs.
BR312	3U	22" x 7" x 14"	12"	12 lbs.
BR316	3U	22" x 7" x 18"	15"	15 lbs.
BR408	4U	22" x 9" x 10"	8"	12 lbs.
BR412	4U	22" x 9" x 14"	12"	16 lbs.
BR416	4U	22" x 9" x 18"	15"	19 lbs.
BR418W	4U	22" x 10.5" x 21"	17"	23 lbs.
BR512	5U	22" x 10.5" x 14"	12"	21 lbs.
BR516	5U	22" x 10.5" x 18"	15"	23 lbs.



**BR418W**  
HEAVY-DUTY TROLLEY SYSTEM ZIP IT UP & ROLL IT AWAY.

## DRUM BAGS

Our drum bags are the ultimate hardware bags for drum kits. 30" and 40" lengths with super tough floorboards, each includes an aluminum telescopic handle, smooth rolling wheels and several handy pockets. Also great for mobile DJ's and for general utility use.

**BDR30W**  
Dims (Exterior): 31" x 15" x 15"  
Weight: 8lbs

**NEW**  
ARRIVAL



Telescopic handle



**BDR42W**  
Dims (Exterior): 41" x 16" x 17"  
Weight: 12 lbs.

## LOAD-N-GO<sup>2</sup>



**EMLG2**

### FEATURES:

- 4" Casters (Two Swivel w/brakes and Two Rigid)
- Expendable Base Platform Extends From 19.5" To 28" In width
- Fully Expendable Handle Extends From 28" To 37" In height
- Foam Padded Handle For Comfortable Pulling and Pushing
- Rugged, Lightweight Aluminum Base Construction
- Weighs Only 19 lbs.
- 250 lbs. Weight Capacity
- Extended Dims: 28"W X 38"H X 16.5"D
- Folded Dims: 19.5"W X 8"H X 16.5"D



## DOLLY PLATES

Our rugged dolly plates feature heavy-duty casters and two super stop brakes. Save your back and roll into your next gig with ease.

48" Width!



ADP2448



FZWMP

FZADP



ADP30E

ADP30P



Haul EVERYTHING you need on the ADP2448 (Strap and equipment not included)

MODEL	DESCRIPTION	DIMENSIONS	WEIGHT
ADP2448	(4) 4.0 in. pro casters	48" x 24" (Carpeted)	35 lbs.
ADP30E	(4) 3.0 in. regular casters	21" x 24"	12 lbs.
ADP30P	(4) 3.0 in. pro casters	21" x 24"	15 lbs.
FZADP	(4) 3.5 in. pro casters	20.5" x 24" (for Flight Zone Amp Racks)	18 lbs.
FZWMP	(4) 3.5 in. pro casters	20.5" x 21.25" (for Flight Zone Combo Racks)	18 lbs.

**NEW**  
ARRIVAL

# ROCK N ROLLER® MULTI-CART®

## An Essential for DJs

Moves huge amounts of gear.  
 Folds small for easy storage.  
 High-tech swivel casters.  
 Dependable steel frame.



**Best selling equipment cart in the music industry!**

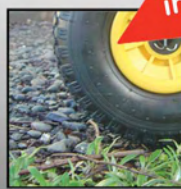

Wide air-filled all-terrain wheels help navigate grass and gravel.



Two-wheeler configuration takes steps easier with the help of a built-in stair-stepper bar.



Most DJs can move all of their gear, including PA, in one trip.



Optional top shelf & lower deck kits add on-site versatility.



Perfect behind-the-scenes work desk for running lights, show production & recording.

Instantly transforms into any of eight configurations.



Tough, textured finish resists equipment slippage.

**ROCK N ROLLER®  
MULTI-CART®**

## ROCK N ROLLER® MULTI-CARTS® 8-IN-1 EQUIPMENT TRANSPORTS



### OR2

OR2-MICRO MULTI-CART: Frame telescopes from 26"-39" in length with 25"/20" (front/rear) foldable sides. 6"x1.50" rear wheels and 4"x1.0" front swivel casters.  
 Load capacity: 350 lbs./24 cu. ft.  
 Weight: 17 lbs.



### OR6

OR6-MINI MULTI-CART: Frame telescopes from 28"-42.5" in length with 24" foldable sides. 8"x2.50" pneumatic rear wheels and 4"x1.0" front swivel casters.  
 Load capacity: 500 lbs./27 cu. ft.  
 Weight: 25 lbs.



### OR8

OR8-MID MULTI-CART: Frame telescopes 34"-52" in length identical to R10 except with 8"x2.50" pneumatic rear wheels resulting in 20% smaller storage footprint than OR10. Load capacity: 500 lbs./32 cu. ft.  
 Weight: 29 lbs.



### OR10

OR10-MAX MULTI-CART (BEST SELLER): Frame telescopes 34"-52" in length with 32" foldable sides to stack loads high. 10"x3.0" pneumatic rear wheels. 5"x1.25" front swivel casters.  
 Load capacity: 500 lbs./32 cu. ft.  
 Weight: 31 lbs.



### OR12

OR12-ALL-TERRAIN MULTI-CART: Frame telescopes 34"-52" in length with 32" foldable sides to stack loads high. 10"x3.0" pneumatic rear wheels and 8"x2.50" pneumatic swivel casters.  
 Load capacity: 500 lbs./32 cu. ft.  
 Weight: 36 lbs.



### ORSHKT10

ORSHFKT10-EXPANDABLE SHELF KIT: Converts a Multi-Cart in seconds into long (52"x18") or short (34"x18") shelf cart. Shelf quickly detaches and breaks down for small storage (30"x18"x2"). Carpet-covered 1/2" plywood with powder-coated.  
 Weight: 16 lbs.

## COMPACT COLOR CHANGING LED KEYBOARDS

U.S. AND FOREIGN PATENT PENDING

**CONTROL SL**



\*Computer is not included

Serato Scratch Live DJ's as well as Traktor Scratch (2nd Gen. or later Only) users are now in total control with Odyssey's Control SL keyboard controller (Pat. Pending) Easy to manipulate color coded shortcut keys allow you the artist to be more creative and have the flexibility to concentrate on what matters, the music.



Easily visible color coded Serato shortcut key layout for both left and right CD/turntable decks



Perfect to use with your Odyssey Glide Style Laptop Cases! 7 Color LED lit keys great for visibility in any dark club environment



3 additional USB ports. Great for any Guest DJ's USB Harddrive Connectivity!

### KEY FEATURES:

- PC & MAC compatible
- Easily visible color coded Serato shortcut key layout for both left and right CD/turntable decks.
- 7 Color Backlit LED keys great for visibility in any dark club environment. Set your color preference or choose from two built-in color changing modes.
- Connect up to 3 additional USB devices
- Compatible Serato Scratch Live DJ and Traktor Scratch ( second generation only.)
- 12.625"W x 0.375-0.875"H x 6.75"D
- Weight: 1 lb.

Also available:

## BACKLIT LED USB KEYBOARD



AIDJ2KEY

### FEATURES INCLUDE:

- Dimensions 12" x .5"x 6"
- Cord is about 56" long
- Weight: 1 lb.

This universal keyboard is perfect for Digital DJ's. Accessorize your rack tray with the warm white glow of this fully lighted keyboard. PC and Mac compatible.

## ColorKey™

Compact LED Keyboard

U.S. AND FOREIGN PATENT PENDING



### COLORKEY FEATURES:

- PC & MAC compatible
- 7 Color Backlit LED keys great for visibility in any dark club environment. Set your color preference or choose from two built-in color changing modes
- Connect up to 3 additional USB devices
- Power supply adaptor and Sleek Keyboard pouch included
- 12.63"W x 0.38-0.88"H x 6.75"D



Power adaptor and keyboard pouch included with COLORKEY

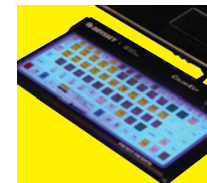

7 Color LED lit keys great for visibility in any dark club environment



Perfect to use with your Odyssey Glide Style Laptop Cases!



3 additional USB ports. Great for any Guest DJ's USB, hard drive Connectivity!

## ControlSkin™ FOR SERATO & TRAKTOR SCRATCH

(Second generation or later)

U.S. AND FOREIGN PATENT PENDING

### CONTROLSKIN FEATURES:

- Made for Colorkey
- Clear non-slip rubber construction
- Serato / Traktor Scratch shortcuts
- Can be placed or removed over the ColorKey quick and easy in no time at all.



## ControlKit™ LED KEYBOARD & CONTROL SKIN KIT

KIT INCLUDES:

**ColorKey™**  
Compact LED Keyboard

**ControlSkin™**



MODEL	WEIGHT	FITS
COLORKEY	1 lb.	Compact color-changing LED keyboard
CONTROLSKIN	0.5 lb.	Serato / Traktor Scratch keyboard skin for the COLORKEY
CONTROLKIT	3 lbs.	COLORKEY & COLORSKIN all-in-one package

Visit our website for more details on these items.

## FOLD-OUT STANDS CARPET SERIES



CF2636

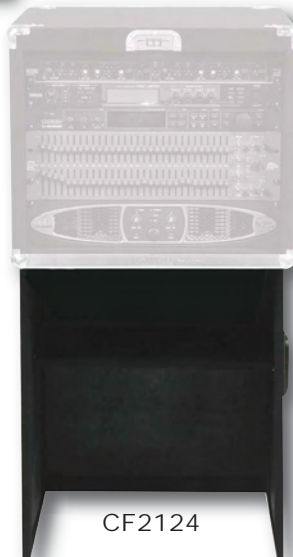

CF2124

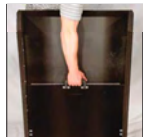

handle shelf folds down for easy carrying



heavy-duty custom clip holds shelf in place for stability and storage



sides fold in for compact transport

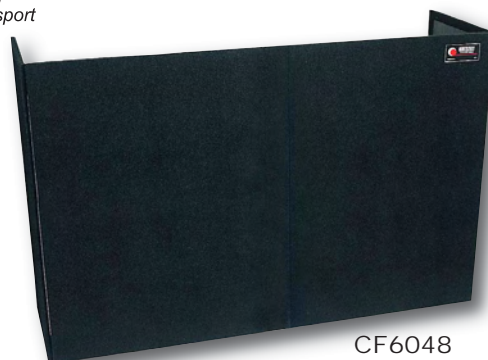

CF6048

- Made of multi-layered plywood
- Covered with heavy-duty Carpet
- Easy to set-up and tear down
- 180 lbs. maximum load (evenly distributed)

MODEL	DIMENSIONS	WEIGHT	BEST USE FOR:
CF2124	21" x 24" x 17.5"	26 lbs.	racks, cases, and consoles
CF2128	21" x 28" x 17.5"	28 lbs.	racks, cases, and consoles
CF2636	26" x 36" x 16"	32 lbs.	coffins, consoles
CF3630	36" x 30" x 17.5"	38 lbs.	coffins, consoles
CF3634	36" x 34" x 17.5"	40 lbs.	coffins, consoles
CF6048	60" x 48" x 18.5"	50 lbs.	facade (no center shelf)

## FOLD-OUT STANDS FLIGHT ZONE SERIES

FZF3336



FZF5437T

Fully folded with latches closed

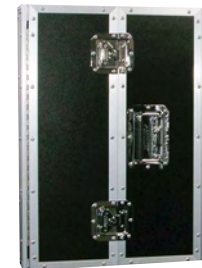

Perfect for DJ Coffins, Consoles, and Combo Racks



FZF1926

Shelf securely snaps down in place

### FLIGHT ZONE FOLD-OUT COMBO TABLE STAND FZF5437T



STEP 1

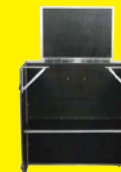

STEP 2

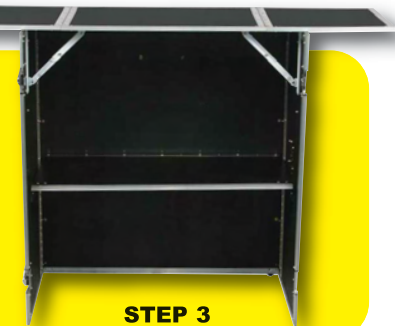

STEP 3

Our Flight Zone folding table stands are perfect companion pieces for the DJ who likes to go completely modular. Use for a home studio set up or on stage. Showing off your gear and talent never looked better with our foldout table stands. Made of black laminate and aluminum valance edging, these stands provide a clean, professional appearance that's easy to setup and teardown. Black Label™ Series also available. (pg12)

MODEL	DIMENSIONS	WEIGHT
FZF1930	(Exp'd) 19" x 30" x 18.5"	26 lbs.
FZF1926	(Exp'd) 19" x 26" x 18.5"	22 lbs.
FZF2636	(Exp'd) 26" x 36" x 18.5"	30 lbs.
FZF3336	(Exp'd) 33" x 36" x 18.5"	33 lbs.
FZF5437T	(Exp'd) 54" x 37" x 18.5"	45 lbs.

## X STAND



Anti-slip rubber padding helps keep gear in place.

Exclusive 10 way adjustable twin bracing design for added strength.

THE STRONGEST DJ X STAND IN THE INDUSTRY!

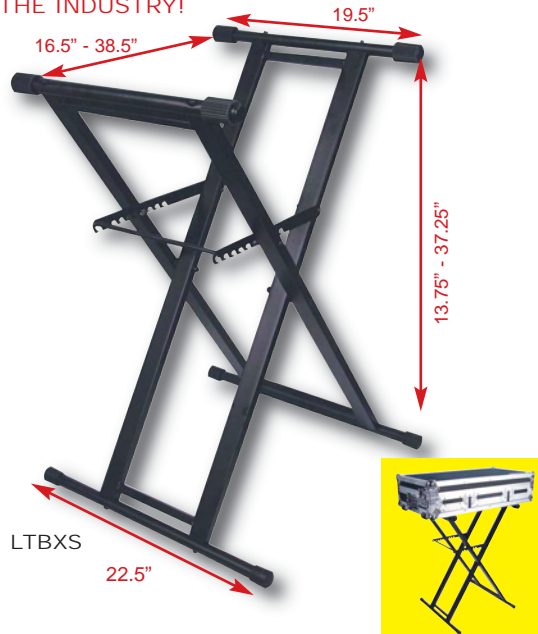

### EXCLUSIVE FEATURES

- Designed to support DJ Coffins
- Solid twin steel bracing with extra deep support bars to support larger gear
- Extra deep base for added stability
- Anti-slip rubber pads
- 200 lbs. maximum load (evenly distributed)
- Folded Dims: 15" x 10.25" x 2.75"
- Weight: 20 lbs.

## X STAND "TWO"

The LTBXS2 (X-Stand 2) is versatile and compact, folding into a space smaller than most guitar cases. Each tier allows independent height and width adjustment for holding keyboards, DJ Coffins, CD coffins and even laptop cases.



LTBXS2



FEATURES 1" TUBES FOR EXTRA STRONG SUPPORT



**Adjustable top tier**  
width: 22.75-42.50"  
height: 14-19.25"  
depth: 18.50-21.50"

Folded Dimensions with top tier  
width: 23.50"  
height: 59.50"  
depth: 3.75"

**Other Specs**  
• 12.5-37.25"W x 18.75-38.2"H x 22.5"D  
• Weight: 23 lbs.

Folded Dimensions without top tier  
width: 23.50"  
height: 41"  
depth: 3.75"

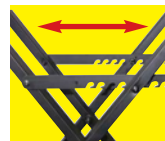

## TRUSS TABLES

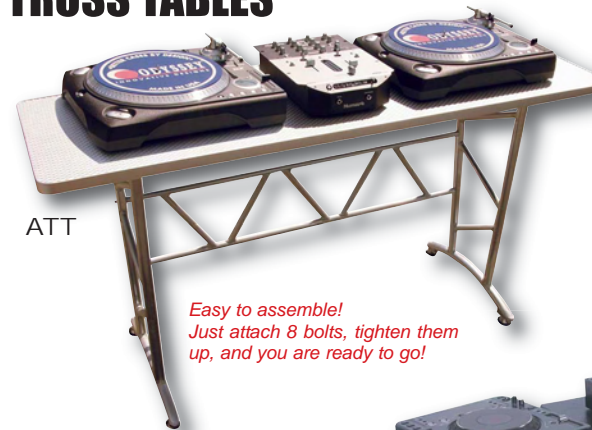

ATT

Easy to assemble!  
Just attach 8 bolts, tighten them up, and you are ready to go!

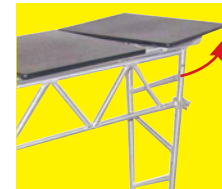

Rotating wings allow more ergonomic playing positions!

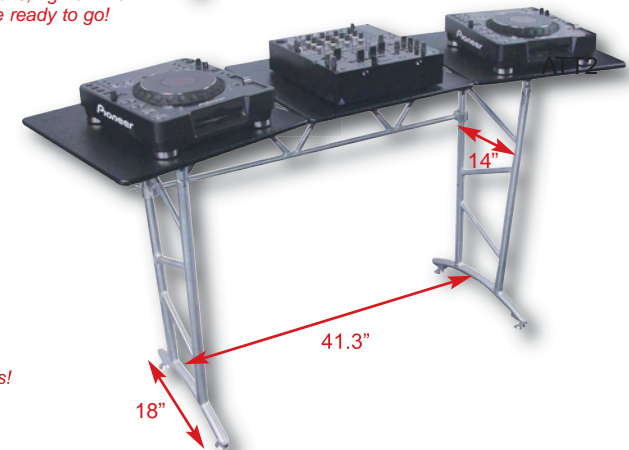

The ATT2 features fold flat portability, and swiveling side platforms. Each of the 3 tabletop measures: 19.5" x 19.5". Together, they measure 66.25"(w) x 25"(d) when sides are fully angled.

FOLD DOWN AND GO IN SECONDS!



MODEL	DIMENSIONS	WEIGHT
ATT	59.25" x 35.25" x 20"	44 lbs.
ATT2	60" x 35.25" x 19.5"	35 lbs.

## CARPETED DJ TABLE

Use this sturdy and clean looking work surface to set up your system or music. This professional table comes with a pre-tapped port hole for cable runs and a strap-handle for easy carrying. The folding leg system is height-adjustable from 26" to 38"

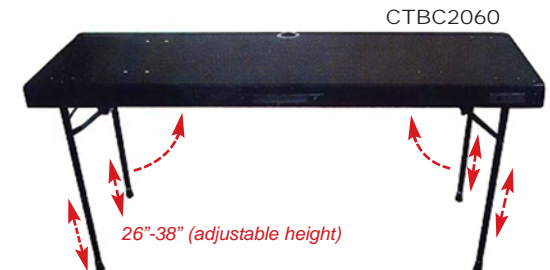

CTBC2060

26"-38" (adjustable height)

MODEL	DIMENSIONS	WEIGHT
CTBC2060	60" x 26"-38" x 20"	29 lbs.

# LSTAND • LAPTOP/GEAR STANDS

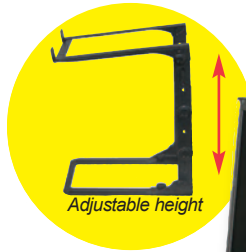

## U.S. AND FOREIGN PATENT PENDING

Finally, the digital DJ STAND you have been asking for; Odyssey's folding DJ LSTAND MOBILE. The Odyssey LSTAND MOBILE is a light and portable stand to place your laptop, CD player/controller, EFX/Drum machines or lighting controller. Odyssey's LSTAND MOBILE comes complete with stand alone legs for a table top configuration and clamps so it can be attached to the edge of a table or the wall of your case just the way you like.

Case Clamp Configuration with optional Lstand tray shown



Corner Case Clamp Configuration Adjustable height 11"-14.5"



\*Shown with optional Lstand tray.

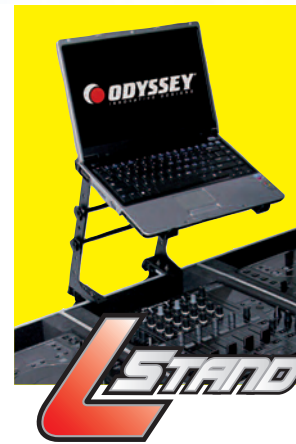
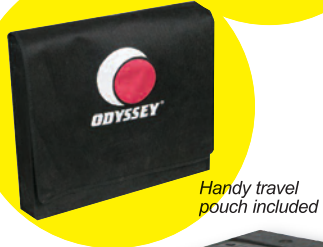

Stand alone configuration shown with optional LStand Tray for Serato or other audio interface

Table Clamp Configuration

Case Clamp Configuration

Our LSTAND is the most versatile laptop stand on the market! Our unique design allows for three basic configurations: table top, clamped to a table, or clamped to the wall of a case or other sturdy vertical structure. Set it low for a minimal clearance of 6.75" or set it up to 11.5" high. The 10.75" long support arms hold gear with a width of 9" or greater.

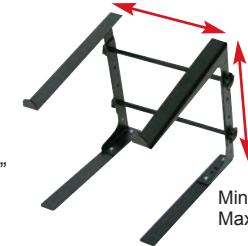

Minimum Width: 10.5"  
Maximum Width: 13.5"

Minimum Height: 9.5"  
Maximum Height: 14.5"

## OPTIONAL: LSTANDTRAY

Keep your interface or controller ventilated and close at hand with this adjustable tray. Great for Serato, Traktor and other DJ gear.

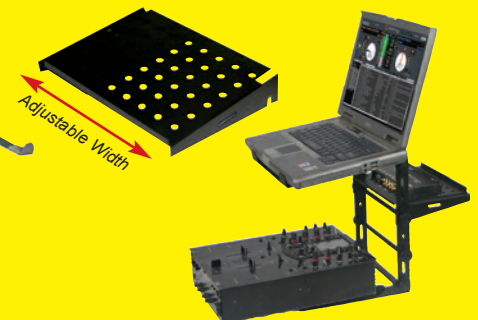

MODEL	WEIGHT	DESCRIPTION
Lstand-S	5 lbs.	L Stand stand alone
Lstand	6 lbs.	L Stand with table/case clamps set
Lstand Combo	8 lbs.	L Stand with table/case clamps and Lstand Tray set
Lstandtray	2 lbs.	Ventilated adjustable tray for Serato, Traktor and other DJ gear.

# Make A Statement That Screams Louder Than Cool!

## Introducing the all new LSTAND Designer DJ™ Series

Make a statement that screams louder than COOL with the NEW LSTAND Designer DJ™ Series. We've added a sharp twist to the "original" ever popular adjustable DJ laptop stand design. Now you can choose from a wide spectrum of colors to fit your personality, your image, and your style.

## DESIGNER DJ™ LSTAND LAPTOP STANDS & ACCESSORIES

Our LSTAND is the most versatile laptop stand on the market! Our unique design allows for three basic configurations: table top, clamped to a table, or clamped to the wall of a case or other sturdy vertical structure. Set it low for a minimal clearance of 6.75" or set it up to 11.5" high. The 10.75" long support arms hold gear with a width of 9" or greater.



**LSTAND\***  
Includes LSTAND CLAMPS for table and case clamp configuration  
(\*See below for all available colors)

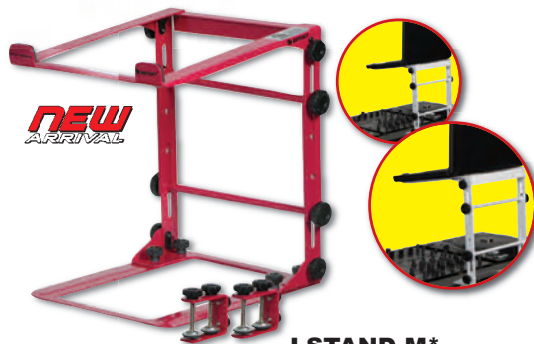

**LSTAND-M\***  
Folding L Stand system with table/case clamps



**LSTAND-S\***  
Stand alone laptop stand  
(\*See below for all available colors)



**LSTAND CLAMPS\***  
Pair of clamps available separately  
(\*See below for all available colors)



**LSTAND TRAY\***  
Optional accessory tray  
(\*See below for all available colors)

MODEL	WEIGHT	DESCRIPTION
LSTAND-S*	5 lbs.	Stand alone L Stand
LSTAND*	6 lbs.	6 Stand with table/case clamps
LSTANDTRAY*	2 lbs.	Ventilated adjustable tray for Serato, hard drive or other gear
LSTANDM*	6 lbs.	Folding L Stand system with table/case clamps
LSTANDCLAMPS*	2 lbs.	pair of table/case clamps for L Stands

\*AVAILABLE COLORS FOR DESIGNER DJ™ SERIES LSTANDS & ACCESSORIES:

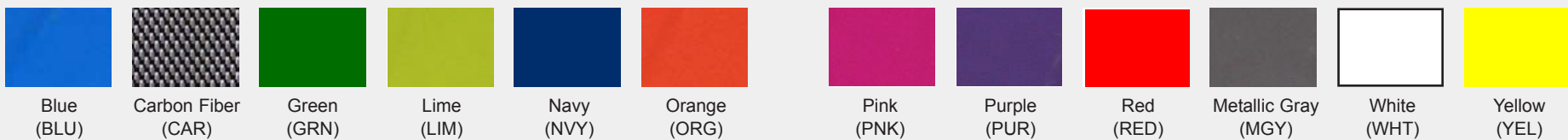

**L-EVATION**  
 THE ULTIMATE DJ GEAR STAND

**HEAVY-DUTY LAPTOP/GEAR STANDS AND ACCESSORIES**

**LCDJSP**  
 The LCDJSP is made to hold a Pioneer CDJ1000 player.



**LUNISP**  
 This universal L-Elevation stand has adjustable depth support for your laptops, most tabletop CD players, effects units, and other pro gears.

**L-EVATION DUAL ARM PACKAGES:**

**LCDJSPDB**  
 Includes:  
 •1 LCDJSP  
 •1 LCDJPLATE  
 •1 LDBARM



**LUNISPDB**  
 Includes:  
 • 1 LUNISP  
 • 1 LUNIPLATE  
 • 1 LDBARM



**LCDJUNIDB**  
 Includes:  
 •1 LCDJSP  
 •1 LUNIPLATE  
 •1 LDBARM



**L3UNI**  
 Includes:  
 •1 LUNISP •2 LUNIPLATE •1 LDBARM  
 •1 L20POLE



**L2CDJUNI**  
 Includes:  
 •1 LCDJSP •1 LCDJPLATE •1 LUNIPLATE  
 •1 LDBARM •1 L20POLE

**L20POLE**  
 20" long accessory pole for L-Evation stands

**LUNIPLATE**  
 Universal laptop/gear plate for LDBARM, a L-Evation double arm accessory.

**LDBARM**  
 Double arm accessory for L-Evation stands

**LCDJPLATE**  
 Pioneer CDJ-1000 plate for LDBARM, a L-Evation double arm accessory.

Standard single plate arm and base plate come with the LCDJSP and LUNISP L-Elevation stand packages.

Elevate your laptop and pro audio gear in style with our new heavy-duty L-Evation stands. L-Evation stands are easy to assemble and customize with their adjustable height and strong support arm. Set it up over your turntable, mixer, etc. to give you comfortable, easy access to more tabletop gear.

MODEL	WEIGHT	DESCRIPTION:
LCDJSP	31 lbs.	L-Evation stand package made to hold a Pioneer CDJ1000
LUNISP	32 lbs.	Universal L-Elevation Stand with adjustable depth can accommodate a laptop, most table top CD Players, effect units or other pro gear
MODEL	WEIGHT	DESCRIPTION:
L20POLE	6 lbs.	21" pole (five inches taller than the standard pole)
LUNIPLATE	7 lbs.	Universal Plate holds most Laptops, CD decks, Effect units, and Mixers.
LDBARM	6 lbs.	Accessory Dual Arm for L-EVATION® Stand
LCDJPLATE	6 lbs.	Plate made specifically to fit the popular Pioneer CDJ1000 CD player



**s120-ontrack.com**



ortofon serato™

## ORTOFON HEADPHONES

**U.S. AUTHORIZED DISTRIBUTOR**

**O-One**  
Studio DJ Headphone



**HO1**

**TECHNICAL SPECIFICATIONS**

- Frequency range 10-22.000 Hz
- Sound pressure level: 112 dB (10mW re. 1kHz)
- Impedance: 40 Ohm
- Weight: 295g (without cable)

**O2**  
DJ Headphone



**HO2**

**TECHNICAL SPECIFICATIONS**

- Frequency range 10-22.000 Hz
- Sound pressure level: 114 dB (10mW re. 1kHz)
- Impedance: 64 Ohm
- Weight: 275g (without cable)

## ORTOFON S-120 SERATO TURNTABLE DJ CARTRIDGE

**U.S. AUTHORIZED DISTRIBUTOR**

The "Ortofon|Serato S-120 DJ Cartridge" has a patent pending design that will virtually "hug the grooves" of a record using a unique suspension system that the two companies have co-designed. All vinyl DJs will benefit from the extreme tracking ability delivered by this revolutionary new cantilever suspension. With 4.0 gms of vertical tracking force, the S-120 achieves an amazing tracking ability of 120 µm compared to the conventional 80 µm at 315Hz, a 50% performance improvement on standard DJ cartridge.



Case available with Concord or OM Kit packages



Replacement Stylus

**AVAILABLE IN:**

- OM Kit Package (case and extra stylus included with cartridge mounted on a SH4 Serato headshell)
- Concord Kit Package
- Concord Twin Kit Package
- Replacement Stylus

ortofon serato

**S-120 CONCORD VERSION**



**OMS-120-S-SH4**  
OM Cartridge pre-mounted on SH4 SERATO Headshell

# ORTOFON TURNTABLE CARTRIDGES & ACCESSORIES

U.S. AUTHORIZED DISTRIBUTOR

## CLUB CARTRIDGES:



OM (headshell Required.)

Concorde

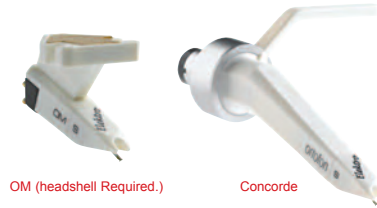

OM (headshell Required.)

Concorde

## DJS

- Basic model for scratching and back-cueing.
- Outstanding rigidity by extra strengthened cantilever.

## ELEKTRO

- Techno cartridge co-designed by DJ's.
- Rubber tube especially developed for scratch and back cueing.
- Very high output



Concorde Kit Package

Concorde Twin Kit Package

Om Single cartridge

Replacement Stylus



Concorde Kit Package

Concorde Twin Kit Package

Om Single cartridge

Replacement Stylus



OM (headshell Required.)

Concorde

## NIGHTCLUBMKII

- The ultimate club cartridge
- Superb sound quality



Concorde Kit Package

Concorde Twin Kit Package

Om Single cartridge

Replacement Stylus

## MF6

- General purpose cartridge
- Low record wear
- Suitable for scratch use



Concorde Kit Package

Replacement Stylus

## RECORDING CARTRIDGES:



OM (headshell Required.)

Concorde

## ARKIV

- Vinyl-to-digital transcription cartridge
- Very good sound quality

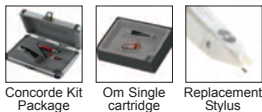

Concorde Kit Package

Om Single cartridge

Replacement Stylus

## CODED VINYL CARTRIDGES:



OM (headshell Required.)

Concorde

## DIGITRACK

- Designed for playback on coded vinyl
- Low record wear
- High output



Concorde Kit Package

Concorde Twin Kit Package

Om Single cartridge

Replacement Stylus

## SCRATCHING CARTRIDGES:

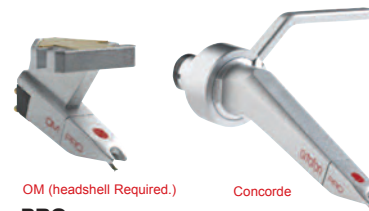

OM (headshell Required.)

Concorde

## PRO

- For general purpose scratching and back-cueing.



Concorde Kit Package

Concorde Twin Kit Package

Om Single cartridge

Replacement Stylus



OM (headshell Required.)

Concorde

## QBERT

- Co-designed by DJ Qbert for scratching and back-cueing
- High tracking ability
- Ultra high output



Concorde Kit Package

Concorde Twin Kit Package

Om Single cartridge

Replacement Stylus

## MF7

- Rugged durability
- Designed for heavy scratching & backcueing
- Good sound quality

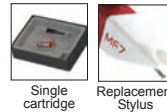

Single cartridge

Replacement Stylus

## HEADSHELLS:



(Serato Headshell)

- big finger lift with short head to make it easier to watch and place your stylus on the groove.
- Gold plated wire terminals for a better signal.
- Available in black, blue, silver, pink, Serato design



OM (headshell Required.)

Concorde

## PROS

- Entry-level cartridge for all purposes



Concorde Kit Package

Concorde Twin Kit Package

Om Single cartridge

Replacement Stylus



OM (headshell Required.)

Concorde

## SCRATCH

- Co-designed by various DJ's
- Especially developed for scratching and back cueing
- Very high output



Concorde Kit Package

Concorde Twin Kit Package

Om Single cartridge

Replacement Stylus

## HOME:



## OMEGA-S

- high-quality, cost-effective cartridge.
- true high-fidelity sound for USB turntables



Single cartridge

## ALSO AVAILABLE:



Original Nightclub series replacement yellow styli. Available in spherical or elliptical.

## TURNTABLE CARTRIDGE CASES



The KCC4 Cartridge Case features our exclusive anti-static foam and a clear plastic lid.

**KCC4**



KCC PRO's feature a spare styli compartment



**KCC2PROBL**



**KCC2PROSL**



**KCC4PROBL**



**KCC4PROSL**

MODEL	DIMS	WEIGHT	DESCRIPTION
KCC2PROBL	5.5" x 2.125" x 4.5"	0.55 lb.	Holds 2 Turntable Needle Cartridges plus spare styli
KCC2PROSL	5.5" x 2.125" x 4.5"	0.55 lb.	Holds 2 Turntable Needle Cartridges plus spare styli
KCC4PROBL	8.25" x 2.125" x 4.5"	1 lb.	Holds 2 Turntable Needle Cartridges plus spare styli
KCC4PROSL	8.25" x 2.125" x 4.5"	1 lb.	Holds 2 Turntable Needle Cartridges plus spare styli
KCC4	7.25" x 1.25" x 3.75"	1 lb.	Holds 4 cartridges and 8 Styli

## DJ CHAIR



Our exclusive design allows you to sit back at a comfortable height, reducing fatigue and stress on your back and legs during those long gigs. Keep the seat up high so you can lean on it while mixing or bring it down low and hide behind your rig in comfort. Seat height has 5 adjustable positions from 21" to 30.75" high. Holds up to 300 lbs. on it's 12" circular foam padded seat. Removeable back rest.

- Dims: 18" x 39" - 47.5" x 17"
- Weight: 35 lbs.

## FACE PLATES

**AFPCDJ1000** (Available while supplies last)

Get our popular Pioneer CDJ-1000 face plates while supplies last. Available in 4 styles. Sure to turn heads and keep your gear looking fresh. Check them out in Chrome, Gold, Silver and Carbon Fiber finishes.



**Silver**



**Carbon Fiber**



**Gold**



**Chrome**

**AFPSL1200**

REVITALIZE AND BLING

These stylish faceplates lend a brand new look to the ever-popular Technics SL-1200 turntables. Are your 1200s scratched and scuffed? Are you embarrassed at gigs where you need to look good? Do you want to keep your new 1200s looking that way for years to come? Our faceplates offer superior protection and make your turntables look amazing. Available in silver and champagne gold.

(Limited Supply Available)



**Champagne Gold**



**Silver**

## BATTLE TRAYS

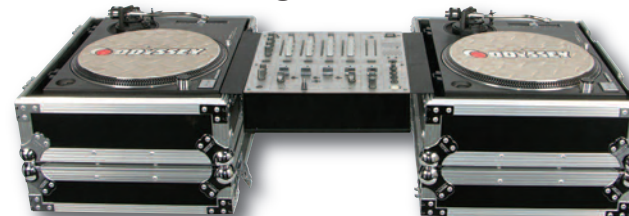

Our 10" & 12" Battle Trays are perfect for setting up a mixer between two cases, raising the mixer surface to allow easier access and quicker moves. Essential for battle DJs using 10" & 12" format mixers.



**FZBB12**



MODEL	DIMS	WEIGHT	DESCRIPTION
FZBB10	12.75" x 3.5" x 19"	1 lb.	10" mixer Battle Tray
FZBB12	14.75" x 3.75" x 19"	1 lb.	12" mixer Battle Tray

# LIGHTING STANDS & ACCESSORIES

**LTP2 12 FT TRIPOD**  
 Black high quality aluminum/steel Lighting tripod stand

- Single T-bar with support bars & (4) hanging bolts
- Tripod extends to 12 feet
- Folds up for easy transport
- Maximum load capacity 80 lbs. evenly distributed
- Weight: 12 lbs.



**LTP6 9 FT TRIPOD**  
 Black Lighting tripod stand highly recommended for pin spots and par cans

- Single T-bar with (4) hanging bolts
- Tripod extends to 9 feet
- Folds up for easy transport
- Maximum load capacity 80 lbs. evenly distributed
- Weight: 11lbs.

**LTP1 12 FT TRIPOD**  
 Black high quality aluminum/steel Lighting tripod stand with 1 T-bar, (2) side bars & support bars

- Tripod extends to 12 feet
- Folds up for easy transport
- Maximum load capacity 100 lbs. evenly distributed
- Includes 8 hanging bolts
- Weight: 14 lbs.

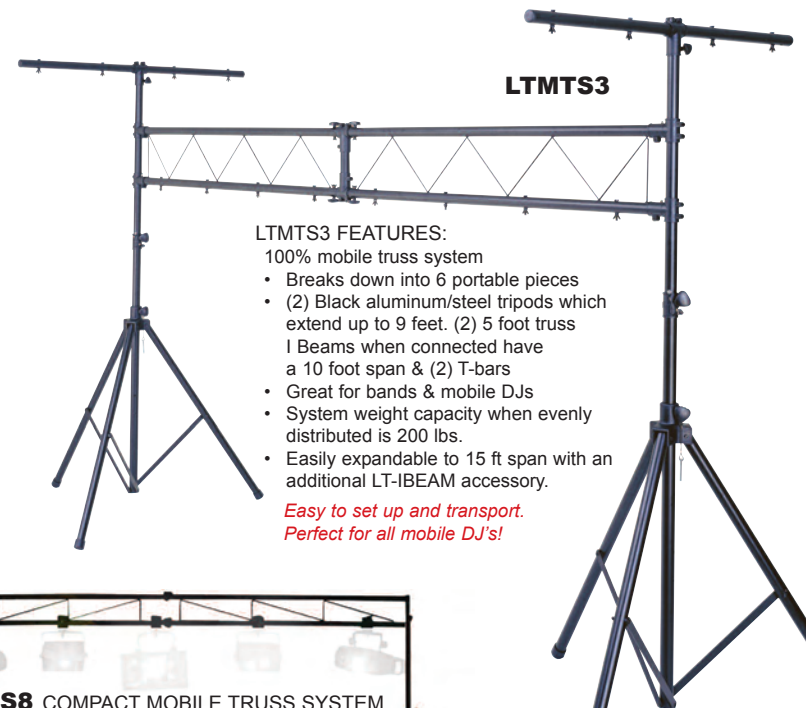

**LTMTS3 FEATURES:**

- 100% mobile truss system
- Breaks down into 6 portable pieces
- (2) Black aluminum/steel tripods which extend up to 9 feet. (2) 5 foot truss I Beams when connected have a 10 foot span & (2) T-bars
- Great for bands & mobile DJs
- System weight capacity when evenly distributed is 200 lbs.
- Easily expandable to 15 ft span with an additional LT-IBEAM accessory.

*Easy to set up and transport.  
 Perfect for all mobile DJ's!*

**NEW**  
 ARRIVAL



**LTMTS8 COMPACT MOBILE TRUSS SYSTEM**

- Breaks down into 4 pieces
- (2) Black aluminum/steel tripods which extend up to 8 feet, 7inches. (2) 4 foot truss I Beams when connected have a 8 foot span
- System weight capacity when evenly distributed is 150 lbs.
- Weight: 23 lbs

*Mounted-Lights and Mobile DJ Setup Shown Not Included*

**ACCESSORIES:**

**LT-IBEAM**



Add this 5 foot truss to extend your 10 foot system to a 15' span

- Truss bar diameter is 1.5"
- Hardware included
- Weight: 9 lbs.

**BLTMTS MTS-3 SYSTEM BAG**



Specially designed to carry a mobile trussing system. Also great for storing other accessories such as tall cymbal stands, mic boom stands, tripods, etc.

**BLTUNI**



Odyssey Universal Tripod Stand Bag  
 Dim: 12" x 63.5"  
 For all Odyssey single tripod stands.  
 Drawstring closure

## SPEAKER STANDS & ACCESSORIES

**LTS2**  
9.5 ft TRIPOD  
Black high quality aluminum/steel tripod stand  
• Tripod extends to 9.5 ft  
• Folds up for easy transport  
• Maximum load capacity 100 lbs.  
• Weight: 8.5 lbs.

**LTS1**  
6 ft TRIPOD  
Black high quality aluminum/steel tripod stand  
• Tripod extends to 6 ft  
• Folds up for easy transport  
• Maximum load capacity 100 lbs.  
• Weight: 7 lbs.

**LTS1W**  
6 ft TRIPOD  
Black high quality aluminum/steel tripod stand with wheels and brakes  
• Tripod extends to 6 ft  
• Folds up for easy transport  
• Maximum load capacity 70 lbs.  
• Weight: 7 lbs.  
• Brakes must be applied when in use

*LATS A1 NOT INCLUDED*

*Features a reversible pole with 1 3/8" on one end and 1 1/2" on the other end*

*Exclusive wheels & brake*

### OPTIONAL ACCESSORIES:



**LATS A1**

Our LATS A1 is used as a mounting platform for speakers, followspot, and select moving head fixtures. This mounting adapter easily slides down on top of most tripod stands. Included are 4 wood screws. 1-3/8" diameter adapter.



**LATS A2**

- 1 1/2" ID speaker mounting adapter
- Mount to the bottom of a speaker

## SPEAKER STAND PACK

The LTS2X2B Speaker Stand Pack comes with two Speakers stands and a carrying bag for easy transport. Each stand holds up to 100 pounds evenly distributed and extends to a height of up to 7 feet. The extension pole includes a built-in system that locks at the highest point so you don't have to worry about over extending the pole and causing the mounted speaker to fall. Tripod also features folding legs and no-slip rubber feet. Pin locks included.



### FEATURES

- Minimum Height: 3.5 feet
- Maximum Height: 7 feet
- Weight of Two Stands with Bag: 19 lbs.
- Single Stand Weights: 9 lbs.
- Speaker Diameter Pole: 1 3/8"

*Carry Bag Included.*

**LTS2X2B**

## SPEAKER CRANK UP EXTENSION POLE

*Approx. 10.25" Height Adjustment*

*Heavy-Duty tension knob keeps it in place*

**CRANK IT UP!**

*43.25" Minimum Height*

**ASCE42**  
Tired of short poles that don't get your tops high enough? Scared of mounting your heavy tops on long poles? Never fear, Odyssey is here with our new Crank Extension Pole. Put it in your sub, mount your speaker and crank it up!

- Comes with pole size adaptors
- Weight is 6 lbs.

# CRANK UP STANDS & ACCESSORIES



### LTP8PRO

Our portable crank T-bar makes it that much easier to get your gear up and running in no time. Utilizing an ingenious internal gear system rather than cables not only makes it safer to use but worry-free for years and years.

- Full cranking height reaches 8.5'.
- Top cross bars is 48"



### LTMTS1-PRO

Our portable 10' span crank truss system features a revolutionary new method to get your lighting up and running in no time. Utilizing an ingenious internal gear system rather than cables, it provides a safer, worry free system.

- Full cranking height reaches 8 ½ feet
- Can handle an evenly spread load of 200 lbs.

Speaker Mount optional



### LTS1PRO

Our super portable speaker stand cranks up to 6' utilizing an ingenious internal gear system. For transporting your tripod system, see our BLTUNI transport bag.



### LTMTS10-PRO

Odyssey LTMTS10-PRO portable square truss system will make any light show a breeze to set up and tear down. It is extremely strong and can handle heavy lighting loads without sagging. Quick release pins ensure safety and easy assembly.

- Full crank height reaches 10'
- Two heavy duty cranks
- Two five feet 12" squared truss
- Max Weight Capacity is 250 lbs. (evenly distributed)
- Weights 147 lbs.

**ACCESSORIES:**

**BLTUNI**

Odyssey Universal Tripod Stand Bag  
 Dim: 12" x 63.5"  
 For all Odyssey single tripod stands.  
 Drawstring closure



**BLTMTS**

Specially designed to carry a mobile trussing system. Also great for storing other accessories such as tall cymbal stands, mic boom stands, tripods, etc.



**LTMT5 / LTMT10**



LTMT5: 5 feet truss piece for LTMTS10-PRO.  
 • 60"W x 12"H x 12"D  
 • 26 lbs.

LTMT10: 10 feet truss piece for LTMTS10-PRO.  
 • 120"W x 12"H x 12"D  
 • 52 lbs.

## VSS™ MOBILE VIDEO SCREEN SYSTEMS

### LTMVSS1014L

Whether your next gig is big or small, you want your video show to be as dramatic and memorable as possible. The best way to enhance the "total experience" of your video display is with our new Mobile VSSL™ video screen system. The VSSL™ systems boasts maximum image quality and luminosity indoors or outdoors. Features front or rear projection. At the maximum stretched point the viewing field is 88" x 60". At the minimum stretched point the viewing field is 80" x 52"



- Max Height is 14'
- Min Height is 6'
- Max Width 10'5"
- Min Width is 8'
- Includes Tripod Frame, Video Screen, Lower Bar Tripod attachment & Carrying Bag
- 55 lbs. with bag
- Video screen (LTMVSCREEN1) & dual tripod frame also sold separately



The entire Mobile VSSL™ system, including the screen, fits into its durable heavy-duty bag, ready for travel or storage, freeing you up to focus on what is really important... your performance.

### LTMVSS8

The Odyssey VSS-8 Mobile Video Screen System is a convenient projection screen display package consisting of one MTS8 Mobile Truss System (LTMVSS8) and one Scrim Werks™ 7' x 5' Projection Stretch Screen (LTMVSCREEN1). Made extra compact & light, it's easy on you back and to store, but still strong and high enough for those essential LED lighting effects for your mobile gig as well as the LTMVSCREEN1 projection stretch screen\*. So simple to set up, it can be done in less than 3 minutes. Just attach the two 4' truss sections together and place on top of the tripods (tighten tension knobs as you go). Then attach the screen loops to the frame knobs, raise the bars to the maximum height, secure, and you're done!



- Front and Rear Projection Screen
- 6'8" x 5' Viewing Field
- Screen made of High Quality Lycra Spandex
- Flame Retardant Treated Screen \*(Retardant must be retreated after washing or dry cleaning)
- Carry Pouch and Attachment Straps For Screen Included
- Max Height is 8'7", Width 8'
- MTS8 Frame Can Handle an Evenly Spread Load of 150 lbs.



## VIDEO PROJECTION STRETCH SCREEN

The Odyssey Scrim Werks™ projection screens can be used for a wide variety of applications from unique outdoor shading configurations attached onto truss or other temporary structures to indoor theatrical or banquet backdrops and projection. Each has sewn in stretch loop points to stretch and secure into various shapes and sizes. Use in conjunction with other Scrim Werks™ products along with colored light washes or small silhouette projections to achieve that extra ambiance to your scrim design (use all safety precautions when using with heat and electrical devices). Carry pouch and attachment straps included.



**LTMVSSCRNLG**  
 SCRIM WERKS 16ft x 6ft  
 PROJECTION STRETCH SCREEN  
 Truss not included



**LTMVSCREEN1**  
 SCRIM WERKS 7ft x 5ft  
 PROJECTION STRETCH SCREEN  
 Truss not included



Three LTMVSCREEN1's  
 used in conjunction with truss  
 Slip Screens

### PROJECTION SCREENS VIEWING FIELDS

MODEL	MAX. VIEWING FIELD	MIN. VIEWING FIELD
LTMVSCREEN1	88" x 60"	80" x 52"
LTMVSSCRNLG	192" x 78"	168" x 60"
LTMVSCRNSM*	72" x 30"	60" x 24" can also be used with tripod light stands

## SCRIMWERKS™ DESIGNER SCRIMS™

The LTMVSCRNSM rectangular screen can be used with any Odyssey LTP light stand nicely covering the length of the support poles with two corner loop points attached to any two bottom legs of the tripod and the other two corner points attached to the ends of the top crossbar. The triangular designer scrims can be used with your speaker and lighting stands set ups for a cleaner and more professional look securing easily to any 2 bottom legs of your tripod and also to the lower pole tension knob covering 1/3 of the bottom tripod leg area.



- Made of High Quality Lycra Spandex
- Material Recovers to Original State After Being Stretched
- Flame Retardant Treated
- Machine Washable \*(flame retardant must be retreated after washing)
- Carry Pouch and Attachment Straps Included

\*LIGHTING EFFECTS AND STAND NOT INCLUDED

MODEL	MAX. STRETCH POINT DIMS.	MIN. STRETCH POINT DIMS.	SHAPE
SPATRILG*	48" x 72"	36" x 60"	Triangular
SPATRILG*	48" x 48"	36" x 36"	Triangular
LTMVSCRNSM*	72" x 30"	60" x 24"	Rectangular

\*available in black(BLK) or white(WHT)



SPATRILGWHT scrims used in conjunction with a LTMVSCREEN1

## SCRIMWERKS™ X STAND SLIP SCREENS™ **NEW ARRIVAL**

Dress up your LTBXS X Stand with Odyssey's new SPALTBXSWHT white Slip Screen™ cover. Simple and easy to use, the SPALTBXSWHT stretches snugly over the top of the X Stand down to the 4 leg points projecting a clean professional look to your set up by keeping your cables hidden from your audience. For an attention grabbing light design, you can use the white Slip Screen™ in conjunction with a small LED color wash effect underneath\*.

(Use all necessary precautions when using with heat and electrical related devices.)



### Features:

- Hassle Free Set-up
- Material Recovers to Original State After Being Stretched
- Flame Retardant Treated
- Reinforced X Stand Leg Pockets
- Machine Washable \*(flame retardant must be retreated after washing)
- Carry Pouch Included
- Exterior Dimensions In Carrying Pouch: 3.5" x 11.5" x 3"

## SCRIMWERKS™ TRUSS SLEEVES SLIP SCREENS™

Presentation is everything to your audience, so when you want to add that extra nice décor to your set up, use Odyssey's new Scrim Werks™ Slip screens. Slip it over a dull or scratched up truss and transform it into a clean white column or illuminate it in glowing majestic colors with an LED light wash. Use in conjunction with other Scrim Werks™ product to create a great background effect and percolate structural ambiance to any outdoor or indoor banquet, rave, or theatrical setting



Fits standard 12" x 12" square truss sticks  
Available in 3 lengths

- TS1205 for 5' long truss
- TS1208 for 8' long truss
- TS1210 for 10' long truss

# ULTRABEAM



Projects a beam of light reaching up to 16 feet away with a 3 foot diameter

The UltraBeam is the ultimate in high intensity LED technology. Weather resistant and durable, it features a universal clip with a 360-degree rotatable head while providing a bright beam of light to clearly illuminate what you are looking at. A must have for every DJ. (Includes two 3 volt 200ma lithium cell batteries)

- Dims: 1" x 2" x 3"
- Weight: 1lb.



**ULTRABEAM**

# CD TRAY GUARD

Detachable Protection Bar

Tired of sending your CD player in for tray repairs due to accidental bumps and swipes? Our CD tray guard puts an end to expensive incidental protruding tray damage. It's also great for hanging your headphones on. Protection bar easily detaches from rack mount attachment.

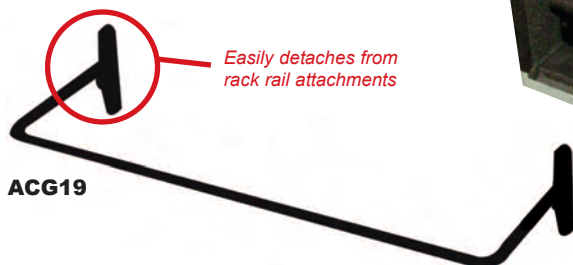

Easily detaches from rack rail attachments

**ACG19**

# Werk Light

Light up that rack with our über-cool, 7 color Werk Light. It's the perfect companion for any pro audio rack. Each model features a built-in color changer that allows you to switch colors with a push of a micro button. It can also change colors automatically for a cool rainbow color morphing effect. The virtually unbreakable LED plexi-tube lasts for years without having to worry about bulbs burning out. Stays cool to the touch while giving your rack a hot new look.



## WERK LIGHT 2500



- 2 color changing modes (scroll and solid)
- 7 colors
- 19" rackmount
- Dims: 19" x 1.75" x 3.5"
- Weight 2 lbs.

## WERK LIGHT 3500



- 8 rear outlets + 1 in front
- Random color changing
- slow/fast color changing
- Auto color mixing fade in/out
- 7 colors
- Dims: 19" x 1.75" x 6"
- Weight: 5 lbs.

# RACK ACCESSORIES

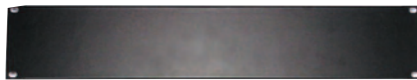

AVAILABLE IN 4 DIFFERENT SIZES. Solid steel blank panels are great for covering empty rack space. Also useful for keeping long cables or other loose items inside the rack during transport.

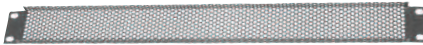

This raised panel deters unauthorized persons from adjusting the gear covered. Large perforations allow visual confirmation of settings without removal while also allowing air flow.



Fan Panel



AFAN45



ARPOT1

## BLANK PANELS

MODEL	DESCRIPTION
APB01	Blank Panel - 1U (1.75")
APB02	Blank Panel - 2U (3.50")
APB03	Blank Panel - 3U (5.25")
APB04	Blank Panel - 4U (7.00")

## VENT SLOTTED PANELS

MODEL	DESCRIPTION
APV01	Vent Panel - 1U (1.75")
APV02	Vent Panel - 2U (3.50")

## LARGE PERFORATED PANELS

ALLOWS MORE AIR FLOW

MODEL	DESCRIPTION
ARPVLP-1	1U (1.75")
ARPVLP-2	2U (3.50")
ARPVLP-3	3U (5.25")
ARPVLP-4	4U (7.00")

## SECURITY PANELS

MODEL	DESCRIPTION
ARSCLP01	1U (1.75")
ARSCLP02	2U (3.50")
ARSCLP03	3U (5.25")
ARSCLP04	4U (7.00")

## FAN PANELS

MODEL	DESCRIPTION
AFP01	3u (5.25") accommodates (1) AFAN45
AFP02	3u (5.25") accommodates (2) AFAN45
AFP03	3u (5.25") accommodates (3) AFAN45
AFAN45	4.5" Panel Mount Cooling Fan - 115 VAC (mounting screws not included)

## RACK TRAY

MODEL	DESCRIPTION
ARPOT1	1u TRAY SLIDES OUT 13.5" FROM RACK RAILS



Perfect for rackable gear without rack ears. Especially well suited for studio & permanent installation. Use clamping rack shelves (below) for mounting non rackmount gear in a rack that will be transported.



ASC2



Rack Drawer



Rack Drawer with dice foam



ARTCA-17" Tray Shelf Width



Heavy-duty steel rack rails come 10/32" pre-tapped, ready for installation.

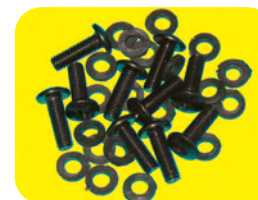

Comes in packages of 25, 50 & 100 Philip head rack screws and nylon washers.

## RACK SHELVES

MODEL	DESCRIPTION
ARS1	Rack Shelf - 1U (1.75") high, 10.00" deep
ARS2	Rack Shelf - 2U (3.50") high, 14.50" deep
ARS3	Rack Shelf - 3U (5.25") high, 14.50" deep
ARS4	Rack Shelf - 4U (7.00") high, 14.50" deep

## CLAMPING RACK SHELVES

MODEL	DESCRIPTION
ASC2	2U (3.50") high, 14.50" deep with clamping mechanism
ASC3	3U (5.25") high, 14.50" deep with clamping mechanism
ASC4	4U (7.00") high, 14.50" deep with clamping mechanism

Front & rear clamps hold your non-rackable gear in place during transport. Slide the gear in and lower and tighten the two clamps.

## RACK DRAWERS

These fully enclosed metal drawers are designed to mount directly into equipment rackrails. Comes equipped with a key lock to deter unwanted access.

MODEL	DESCRIPTION
ARDP02	2U (3.50")
ARDP03	3U (5.25")
ARDP04	4U (7.00")
ARDP05	5U (8.75")

MODEL	DESCRIPTION
ADFRD02	2U Drawer with dice foam
ADFRD03	3U Drawer with dice foam
ADFRD04	4U Drawer with dice foam
ADFRD05	5U Drawer with dice foam
ADFRDH	1U Thick Rack Drawer dice foam block

## TOP MOUNT RACK SHELVES 10U

MODEL	DESCRIPTION
ARTCA	Angled top-mount rackshelf
ARSTC	Flat top-mount rackshelf

## RACK RAILS

MODEL	DESCRIPTION
ARR02	2U (3.50") pair of pre-tapped rails
ARR04	4U (7.00") pair of pre-tapped rails
ARR06	6U (10.50") pair of pre-tapped rails
ARR08	8U (14.00") pair of pre-tapped rails
ARR10	10U (17.50") pair of pre-tapped rails
ARR12	12U (21.00") pair of pre-tapped rails
ARR14	14U (24.50") pair of pre-tapped rails
ARR16	16U (28.00") pair of pre-tapped rails
ARR18	18U (31.50") pair of pre-tapped rails

## RACK RAIL SCREWS & WASHERS

MODEL	DESCRIPTION
ASW025	25 rack rail screws & washers
ASW050	50 rack rail screws & washers
ASW100	100 rack rail screws & washers





## AUDIO/VISUAL CASES



### AUDIO/VISUAL CASES



- Plasma cases
- LED cases
- LCD cases
- Projector cases
- Video walls and cubes
- Camera cases
- Shock mount racks
- Media cases
- Wireless mic cases
- Waterproof cases
- Wardrobe cases

## CUSTOM DJ CASES



- Laptop cases
- Printer cases
- Monitor cases
- Computer cases
- Briefcases
- Plotter cases
- Server cases
- Hard drive cases
- Media server cases
- Project cases
- Custom DJ cases

## MUSIC CASES



### TOUR CASES



- Guitar cases
- DJ cases
- Keyboard cases
- Drum cases

## SHIPPING CASES



- Truck packs
- Ramp cases
- Transit cases

## LIGHTING & SOUND/PRODUCTION CASES



- Moving head lights
- Scanners
- Dimmers
- Spot lights
- Lighting consoles
- Laser systems
- LED'S
- Dimmer racks
- Foggers and hazers
- Chain motors & controllers
- Mixing consoles
- Effect / amp / studio racks
- Podiums
- Line array & monitor cases
- Work boxes
- Shock mount racks
- Top load mixer racks
- Rack accessories
- Cable cases
- Trussing

## COMPLETE CUSTOM

- Custom audio cases
- Motion pictures
- Custom in-store displays
- Custom trade show cases
- Military cases
- Medical cases
- Magic cases
- Jewelry cases
- Make-up cases
- Portable bars
- Guns & sporting goods
- OEM cases



## ABOUT BOBADILLA CUSTOM CASES:

BC custom cases are first and foremost designed to protect your valuable gear. Our in depth knowledge in custom case designs, attention to details, as well as quality and craftsmanship has made us the industry standard in product protection. Depending on your product and equipment protection needs, be it for heavy-duty transit or just lightweight carrying cases, BC Cases gives you the assurance of protection you can depend on.

## EXTERIOR MATERIALS

Fiberglass, ABS, and aluminum laminate, birch, industrial, or our all-new lightweight, extremely strong polypropylene plastic. Available in 1/4", 3/8" and 1/2". Call us for details.

## WHAT DIFFERENT COLOR PANELS DO I HAVE TO CHOOSE FROM?

We have a full spectrum of colors to choose from. Ask your salesperson for available colors at the time of your order.

## CAN I ADD CASTERS TO MY CASE?

Yes, you can add casters. Swivel or ridged casters can be mounted right on the case or caster board. Even pneumatic casters are also available.

## DO YOU OFFER STENCIL OR CUSTOM LOGOS ON CASES?

Yes, we do. From basic stencil lettering to silk-screening.

## CAN MY CASES BE LOCKABLE?

Yes, please specify either cam-lock or hasp-lock style butterfly latches when ordering. You can even supply your own custom locks.

## WHAT IS THE WARRANTY ON THE CASES?

We offer a limited lifetime warranty on all of our cases to the original purchaser, which covers normal wear and tear. It does not cover misuse, or anything other than what your case was intended for. Our goal is to protect your gear inside during transport from gig to gig and show after show.